

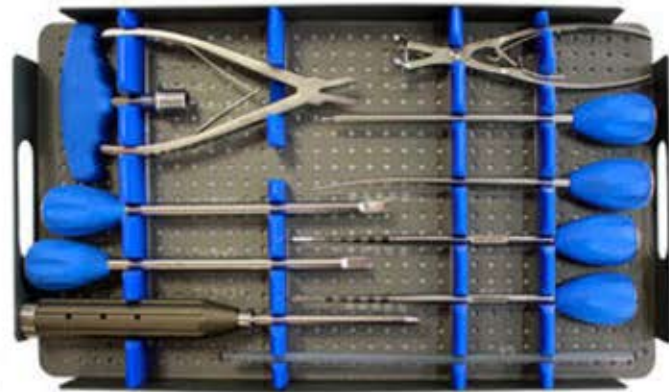

**SURGICAL**  
— STOCK —

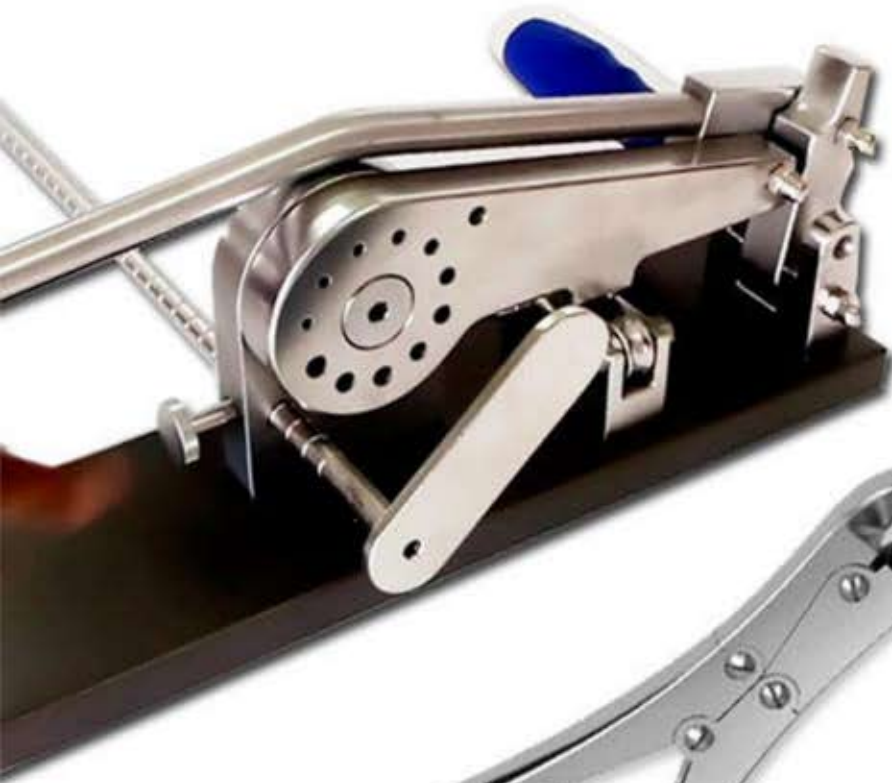

**Orthopedic & Spine Instruments**

# ORTHOPEDIC DRESSING INSTRUMENTS

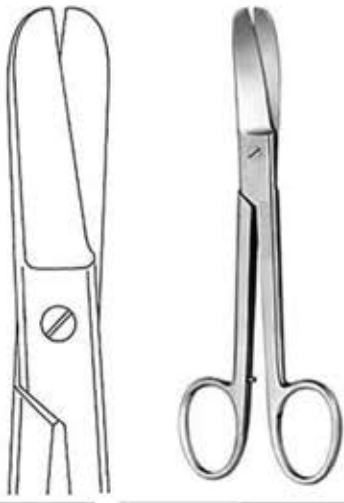

AJ-2036

Lorenz Bandage Scissors  
Heavy Pattern (23 cm / 9")

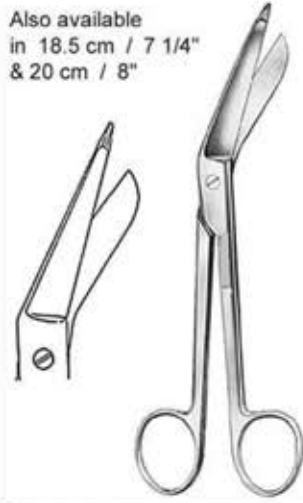

Also available  
in 18.5 cm / 7 1/4"  
& 20 cm / 8"

AJ-2037

Lister Bandage Scissors  
14.5 cm / 5 3/4"

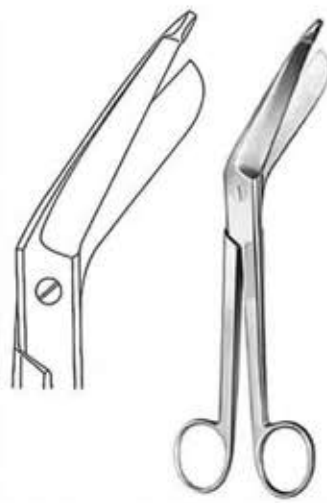

AJ-2038

Bergmann Plaster Shears  
Heavy Pattern  
23.5 cm / 9 1/4"



AJ-2039

Esmarch Plaster Shears  
Heavy Pattern, Short Blades  
20 cm / 8"



Also available  
in 18cm / 7 1/2"

AJ-2040

Bandage Scissors  
16 cm / 6 1/4"  
Black Plastic Rings



AJ-2041

Brun's Plaster Scissors  
24 cm / 9 1/2"  
One Serrated Cutting Edge



B: 26 cm / 10"  
C: 38 cm / 15"

AJ-2042

Stille-Martin  
Plaster Shears  
A: 23 cm / 9"



AJ-2043

Engel Plaster Saw 15.5 cm / 6"



AJ-2044

Hopkins Plaster Knife  
20 cm / 8"  
with Wooden Handle



AJ-2045

Esmarch  
Plaster Knife  
18 cm / 7"



AJ-2046

Reiner  
Plaster Knife  
18 cm / 7"



AJ-2047

Martin  
Plaster Knife  
21 cm / 8 1/4"



AJ-2048

Engel Plaster Saw 15.5 cm / 6"

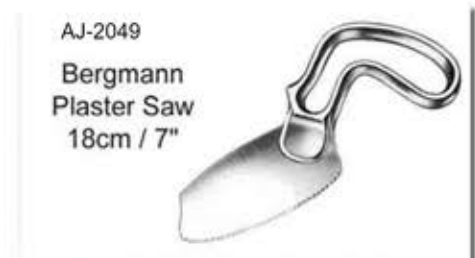

AJ-2049

Bergmann  
Plaster Saw  
18cm / 7"



# PLASTER CAST INSTRUMENTS



AJ-2050  
Hermann Plaster Spreader  
48 cm / 19" Heavy Pattern



AJ-2051  
Hennig Plaster Spreader  
28 cm / 11"



AJ-2052  
Hennig  
Plaster Spreader  
30 cm / 12"



AJ-2053  
Beeson Plaster Spreader  
1.5 In Blade  
30 cm / 12"



AJ-2054  
Walton Plaster Spreader  
w/Spring 3 Prongs  
23 cm / 9"



AJ-2055  
Wolff Plaster Breaker  
A: 18 cm / 7"  
B: 26.5 cm / 10 1/2"



Also Available  
in Non TC  
Version

AJ-2056  
Lister  
Bandage Scissors  
TC / Handle gold  
18 cm / 7"



AJ-2057  
Bruns  
Plaster Scissors  
24 cm / 9 1/2"  
Also Available  
in Non TC  
Version



# AMPUTATION SAWS - GIGLI SAW



AJ-2058 Charrière Amputation Saw  
35 cm / 13 3/4"

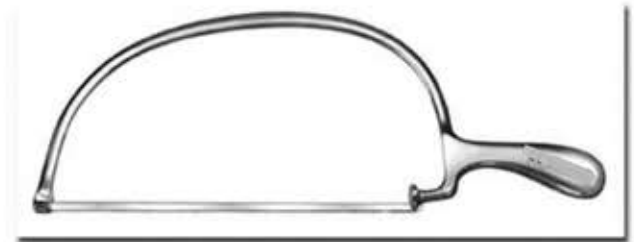

AJ-2059 BIER Amputation Saw  
40.5 cm / 16"

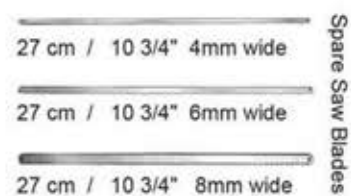

AJ-2060 Langenbeck Amputation Saw  
24.5 cm / 9 3/4"



AJ-2061 Satterlee Amputation Saw 29 cm / 11 1/2"  
Also: Spare Saw Blade Available in 20 cm / 8 1/4" Size



AJ-2062 Charrière Amputation Saw 27 cm / 10 1/2"



AJ-2063 Satterlee Amputation Saw 23 cm / 9"

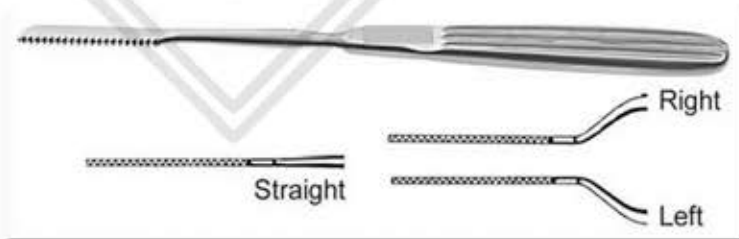

AJ-2064 Joseph Amputation Saw 18 cm / 7"



AJ-2065 Percy Amputation Shield 30 cm / 12"

AJ-2066

- A: Gigli Saw 30cm
- B: Gigli Saw 50cm
- C: Tyler Gigli Saw (Large Cut) 30cm
- D: Tyler Gigli Saw (Large Cut) 30cm

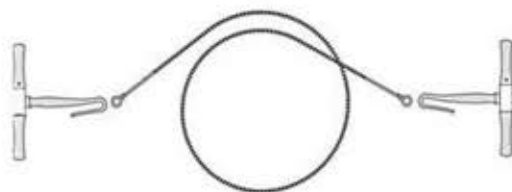

AJ-2067 Gigli  
Sold in Pair

AJ-2068 Struly Gigli  
Sold in Pair



AJ-2069 Gigli  
Sold in Pair

AJ-2070 Struly Gigli  
Sold in Pair

30-135-30  
BAILEY Gigli Saw Guide 30cm

30-136-28  
POPPE Gigli Saw Guide 28cm

# REAMERS - AWLS - BONE HOOKS



AJ-2073

Reamer  
13.5 cm / 5 1/4"



AJ-2074

Perthes Reamer  
18 cm / 7"



AJ-2075

Perthes Reamer  
21.5 cm / 8 1/2"



AJ-2076

Reamer  
One concave side  
14 cm / 5 1/2"



AJ-2077

Glenoid Punch  
20cm / 8"

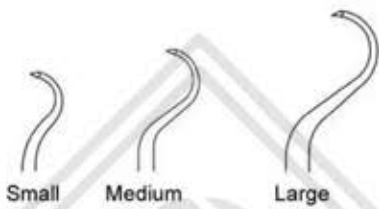

Small

Medium

Large



AJ-2078

Shoulder Percussion Awl  
A: 21.5cm / 8 1/2" B: 23.5cm / 9 1/4"



AJ-2081

Shoulder Penetrating Awl  
Fibre Handle  
A: 18cm / 7" B: 23cm / 9"



AJ-2079

Kuntscher Diamond Awl 28cm / 11"

Pointed

A: 19cm / 7 1/2" 2.5mm  
B: 21cm / 8 1/4" 3mm  
C: 21cm / 8 1/2" 5mm  
D: 26cm / 10 1/2" 6mm

AJ-2080

Rush Awl / Reamer

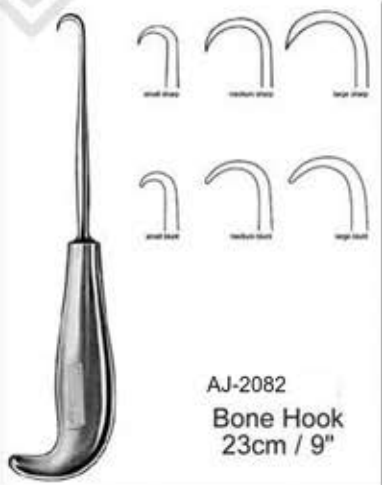

AJ-2082

Bone Hook  
23cm / 9"

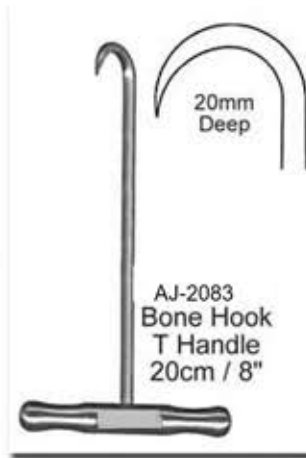

AJ-2083  
Bone Hook  
T Handle  
20cm / 8"



AJ-2084

Bone Hook T Fibre Handle  
14cm / 5 5/8"



AJ-2086

Pointed Awl  
Fibre Handle  
25cm / 10"



AJ-2085

Volkman Bone Hook

A: 20cm / 8" 19X27mm Sharp

B: 23cm / 9" 15X20mm Blunt

C: 23cm / 9" 15X20mm Sharp

C: 25cm / 9 3/4" 15X20mm Sharp



# HAND BONE DRILLS

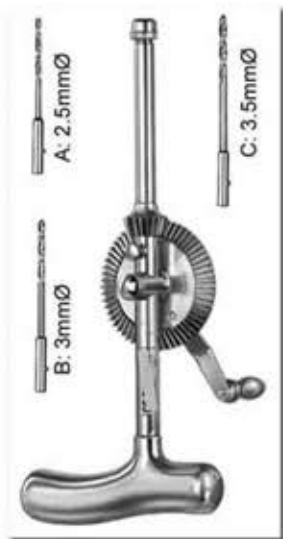

AJ-2087

Stille-Sherman Hand Drill  
24 cm / 9 1/2"  
with 3 twist drills



AJ-2088

Stille Hand Drill  
20.5 cm / 8"  
w/ 9 Twist Drills

Complete with Hand Drill art # 11-138-01

Fig.A: 2.5 mmØ Twist Drill



Fig.B: 3 mmØ Twist Drill



Fig.C: 3.5 mmØ Twist Drill



Fig.D: 4 mmØ Twist Drill



Fig.E: 10 mmØ Trephine



Fig.F: 5 mmØ Spherical Burr



Fig.G: 8 mmØ Spherical Burr



Fig.H: 12 mmØ Spherical Burr



Fig.I: 16 mmØ Spherical Burr



Fig.J: 1 mmØ Twist Drill



Fig.K: 1.5 mmØ Twist Drill



Fig.L: 2 mmØ Twist Drill



AJ-2089

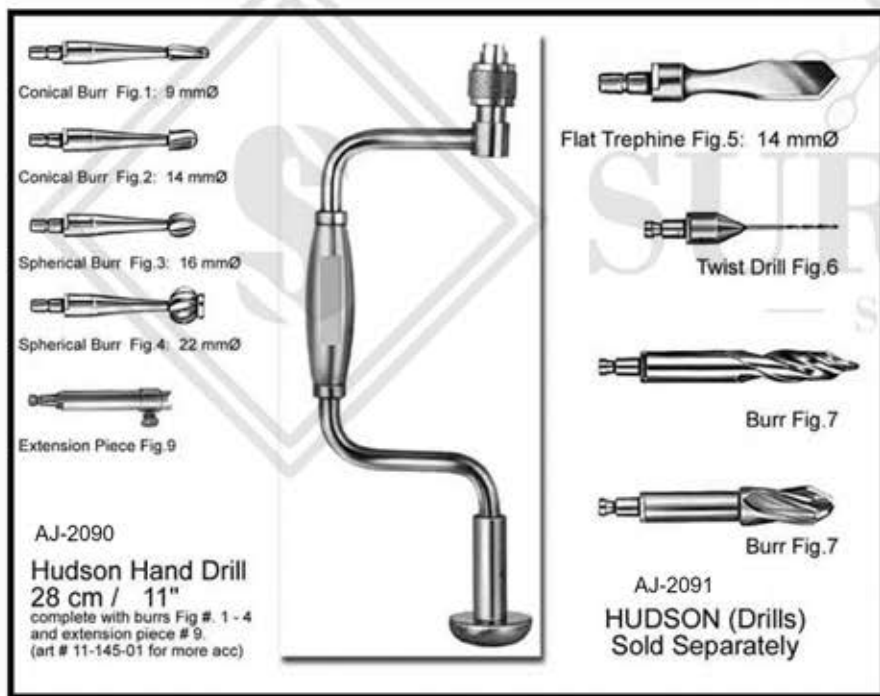

Conical Burr Fig.1: 9 mmØ

Conical Burr Fig.2: 14 mmØ

Spherical Burr Fig.3: 16 mmØ

Spherical Burr Fig.4: 22 mmØ

Extension Piece Fig.9

Flat Trephine Fig.5: 14 mmØ

Twist Drill Fig.6

Burr Fig.7

Burr Fig.7

AJ-2090

Hudson Hand Drill  
28 cm / 11"  
complete with burs Fig #. 1 - 4  
and extension piece # 9.  
(art # 11-145-01 for more acc)

AJ-2091

HUDSON (Drills)  
Sold Separately

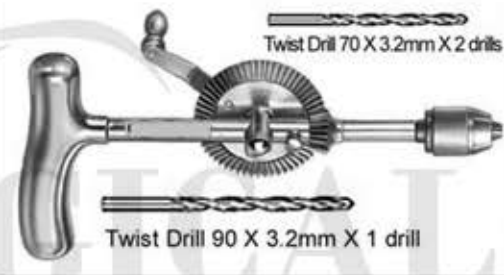

AJ-2092 Moore Hand Drill  
complete with a set of 3 twist drills

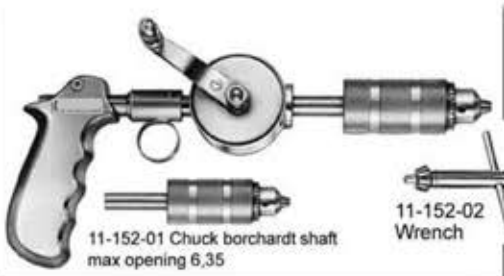

AJ-2093  
Martin Hand Drill with Chuck & Wrench



AJ-2094  
Bunnell Hand Drill  
16cm,

Longitudinally Bored with 3-Jaw-Chuck  
Light Metal Housing  
opening up to 4mmØ



AJ-2095  
Bunnell Type  
Hand Drill 16cm,

Twin Shade Powder Coated  
Longitudinally bored with 3-Jaw-Chuck  
light metal housing opening up to 4mmØ



AJ-2096  
Ralk Hand Drill

Light Metal Housing  
Literally Angled Handle with 3-Jaw-Chuck  
and key, opening up to 6,35mmØ

# HAND BONE DRILLS - KEYS



**Hand Drill**  
All Covered  
Polished / Dull or Coated.  
Drills Holder at Bottom.



**Hand Drill**  
All Covered  
Light Weight  
Polished / Dull or Coated.  
Key Holder and Self Retaining Locking Mechanism



Box for Hand Drills W/ Art #s: 11-450-00 and 11-455-00 Outside Artificial Leather / Inside Jumbo Foam



**Hand Drill**  
Polished / Dull or Coated.  
Operated Horizontally and Vertically



Comes with Keys



**Hand Drill**  
Polished / Dull or Coated.  
All Covered



**Hand Drill**  
Polished / Dull or Coated.  
Open Housing



**Hand Drill**  
Polished / Dull or Coated.  
Open Housing



AJ-2104  
**Hand Drill**  
Polished / Dull or Coated.  
Semi Closed Housing



AJ-2104 Vickers Easidriver 14 cm / 5 1/2"



AJ-2105 14cm / 5 1/2"  
Handle W/ Chuck Longitudinally Bored Accomodating up to 3,95mm



AJ-2107  
Handle with chuck T-Shaped



AJ-2106  
Key

AJ-2108  
Key



AJ-2109  
Fibre T-Handle Key

# DRILL BITTS - BURRS ETC



AJ-2110 5mm Borchardt Shaft Twist Drill  
Long Working End

A: 2.0mm B: 2.5mm C: 3.0mm D: 3.2mm E: 3.5mm F: 4.0mm G: 5.0mm H: 6.0mm I: 7.0mm



AJ-2111 5mm Borchardt Shaft Twist Drill

A: 1.0mm B: 1.5mm C: 1.8mm D: 2.0mm E: 2.2mm F: 2.5mm G: 2.8mm H: 3.0mm I: 3.2mm J: 3.5mm K: 4.0mm L: 5.0mm



AJ-2112 5mm Borchardt Shaft Flat Trepine

A: 1.8mm B: 2.0mm C: 2.2mm D: 2.5mm E: 3.0mm F: 3.5mm G: 4.0mm H: 5.0mm



AJ-2113 5mm Borchardt Shaft Spherical Burr  
A: 3.0mm B: 4.0mm



AJ-2114 5mm Borchardt Shaft Spherical Burr  
A: 3.0mm B: 5.0mm



Long 5mm Borchardt Shaft

AJ-2115 Doyen Spherical Burr

A:4mm B:6mm C:8mm D:10mm E:12mm F:14mm G:16mm

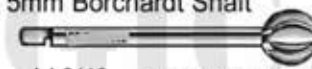

Short 5mm Borchardt Shaft

AJ-2116 Doyen Spherical Burr

A:4mm B:6mm C:8mm D:10mm E:12mm F:14mm G:16mm



AJ-2117 Doyen Conical Burr  
Coarse Spacing 12mm Dia



AJ-2118 Doyen Conical Burr  
Fine Spacing A:8mm / B:10mm



AJ-2119 Doyen Cylindrical Burr  
Coarse Spacing A:12mm / B:15mm



AJ-2120 Albee Burr Oval  
Coarse Spacing A:8mm / B:10mm / C:12mm



AJ-2121 Albee Burr Pointed  
7mm



AJ-2122 Borchardt Burr Oval  
Coarse Spacing 13mm



AJ-2123 Flat Burr  
Short Borchardt Shaft 25mm



AJ-2124 Toti Trepine  
Short Borchardt Shaft 8mm



# BONE HOLDING CLAMPS



AJ-2125  
Standard

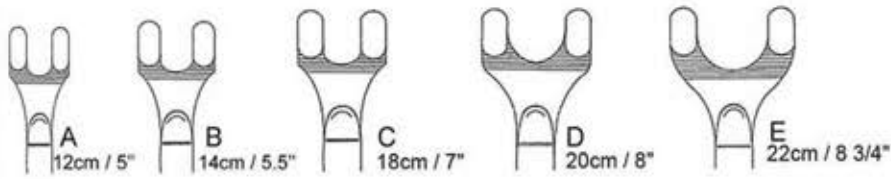

Gerster-Lowman Bone Holding Clamp



AJ-2127

Gerster Traction Bar  
15cm / 6"

AJ-2126  
Angled

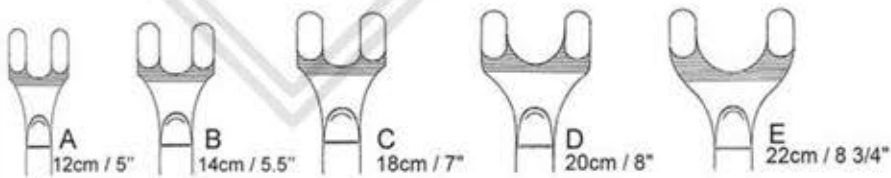

Gerster-Lowman Bone Holding Clamp

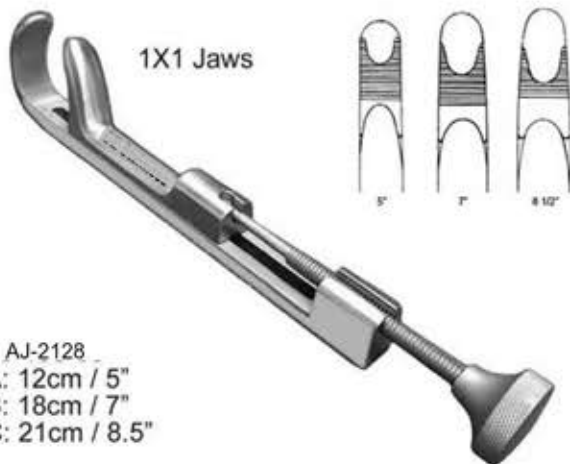

AJ-2128  
A: 12cm / 5"  
B: 18cm / 7"  
C: 21cm / 8.5"

Gerster-Lowman Bone Holding Clamp



AJ-2129  
C: 18cm / 7"  
B: 20cm / 8"

Gerster-Lowman Bone Holding Clamp

# WISE GRIPS - PARALLEL GRIP PLIERS ETC



Flat Nose Plier  
18.5 cm / 7 1/4" Parallel Grip SS



AJ-2132 at Nose Plier / Cutter  
18.5 cm / 7 1/4" Parallel Grip



AJ-2134 Long Nose Plier / 22 cm / 8 1/4"



Vise Grip 20.5 cm / 8"  
Stainless Steel



SLAP HAMMER w/ Threaded Shaft Head  
to be used with AJ-2140 and AJ-2140



SLAP HAMMER w/ Hexa Shaft Head  
to be used with AJ-2141 and AJ-2142



AJ-2143 Regular Jaw Locking Plier  
A: 18 cm / 7" B: 20 cm / 8"  
C: 23 cm / 9"



Vise Grip 23 cm / 9"  
Locking Plier



Vise Grip 20.5 cm / 8"  
Locking Plier



Vise Grip 18 cm / 7"  
Locking Plier



Needle Nose Locking Plier  
30 cm / 12"



AJ-2138  
Needle Nose Locking Plier  
25.5 cm / 10"



AJ-2139  
Needle Nose  
Locking Plier  
22 cm / 8.5"



AJ-2144  
Needle Nose Locking Plier  
A: 22 cm / 8.5"  
B: 25.5 cm / 10"  
C: 30 cm / 12"

# BENDING - WIRE CUTTING PLIERS



AJ-2145  
Combi-Flat Nose Pliers 15 cm / 6"  
for Bending & Cutting



AJ-2146 Round / Flat Nose Pliers  
18 cm / 7"



AJ-2147 Flat Nose Pliers  
17 cm / 6 3/4" with crosswise groove



AJ-2154  
Platypus Nail  
Pulling Forceps  
15.5 cm / 6 1/4"

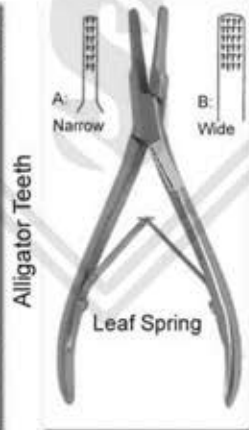

AJ-2155  
Platypus Nail  
Pulling Forceps  
15.5 cm / 6 1/4"

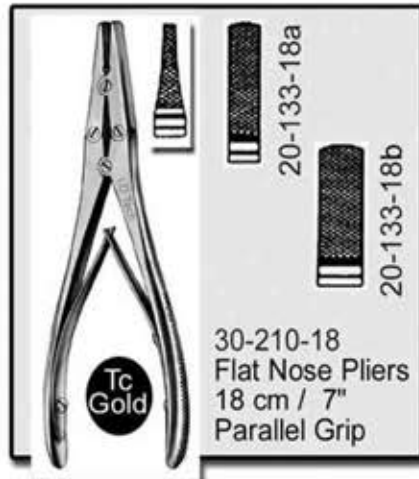

AJ-2152  
Flat Nose Pliers 17.5 cm / 7"



AJ-2156  
Round Nose Pliers  
15.5 cm / 6 1/4"



AJ-2157  
Needle Nose Pliers  
15.5 cm / 6 1/4"

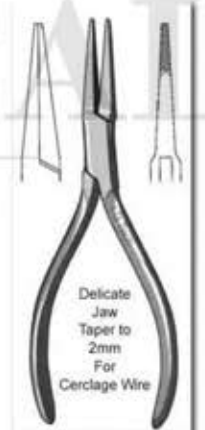

AJ-2158  
Flat Nose Pliers  
15 cm / 6"

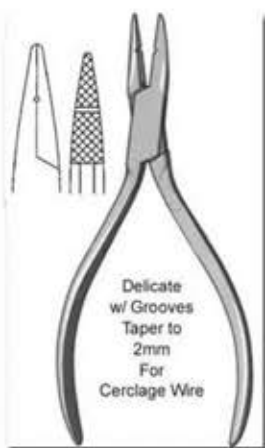

AJ-2159  
Needle Nose Pliers  
13.5 cm / 5 1/4"

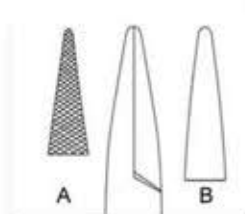

AJ-2160  
Needle Nose Pliers  
Taper to 2mm Tip  
14 cm / 5 1/2"  
A: Fine Cross Serration  
B: Smooth



AJ-2161  
18.5 cm / 7 1/4"  
Wire Cutting Pliers  
Hard wires up to 1.8mm Ø



AJ-2162  
Martin "Diamant"  
Hard wires up to 1.5mm Ø



AJ-2150  
Flat Nose Pliers  
13.5 cm / 5 1/4"



AJ-2151  
Hackstock Flat  
Nose Pliers  
16cm / 6 1/4"



AJ-2153  
Flat Nose Pliers Pointed  
19.5 cm / 7 3/4"



# BENDING - WIRE CUTTING PLIERS



AJ-2163  
14 cm / 5 1/2"  
Circlage Pliers / Cutter



AJ-2164  
20 cm / 8"  
Wire Bending Pliers

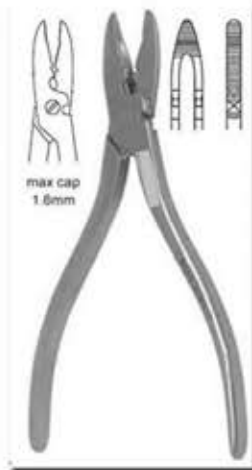

AJ-2165  
15 cm / 6"  
Wire Bending Pliers



AJ-2166  
20 cm / 8"  
Wire Bending Pliers  
TUNGSTEN  
CARBIDE



AJ-2167  
15 cm / 6"  
Needle Nose Pliers



AJ-2168  
14 cm / 5 1/2"  
Flat Nose Pliers

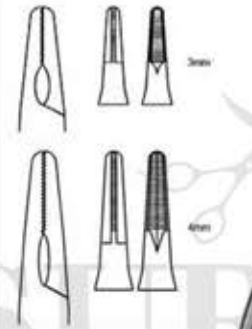

AJ-2169  
K-Wire Pliers  
A: 13 cm / 5"  
B: 17.5 cm / 7"



AJ-2170  
19 cm / 7 1/2"  
Screw/Pin  
Removing Pliers



AJ-2171  
14 cm / 5 1/2"  
Pin Puller  
Grips Small Pins



AJ-2172  
16 cm / 6 1/2"  
Flat Nose Pliers  
w/ Cutter  
for Cerclage Wire



AJ-2173  
19 cm / 7 1/2"  
Narrow  
Nose Pliers  
Heavy Jaws  
for Pulling  
Wire / Pins



AJ-2174  
17.5 cm / 7"  
Long Jaw Pliers  
2inch Long Jaw  
Delicate

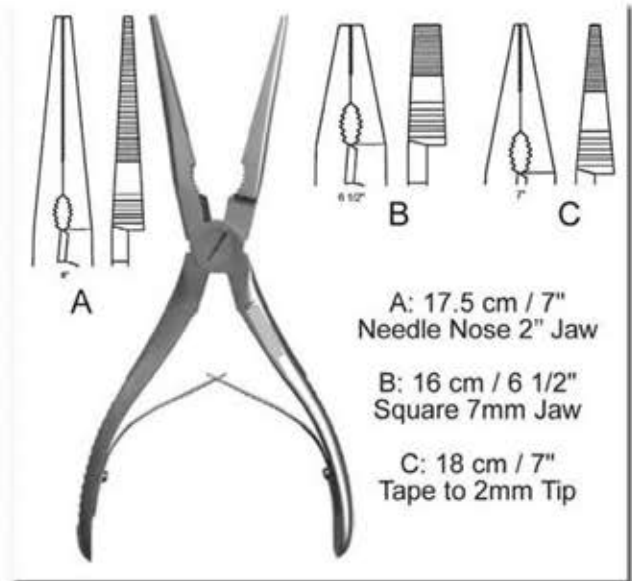

AJ-2175  
UNIVERSAL Pliers  
Serrated w/ Heavyduty Spring and Cutting Edge  
Max Cutting Cap: 1.1mm

# BENDING - PASSERS ETC

All TUNGSTEN CARBIDE

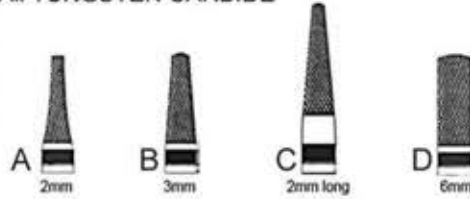

A: 2mm Delicate Jaw TC  
B: 3mm Jaw TC  
C: 2mm Long Jaw TC  
D: 6mm Jaw TC

AJ-2178  
18 cm / 7"  
Double Action Wire Extraction Plier

TC  
GOLD



2"  
Opening  
20 cm / 8"  
Slip Joint Pliers



Max Cap:  
1.6mm  
w/ Cutting  
Edge  
21 cm / 8 1/2"  
Lineman Pliers

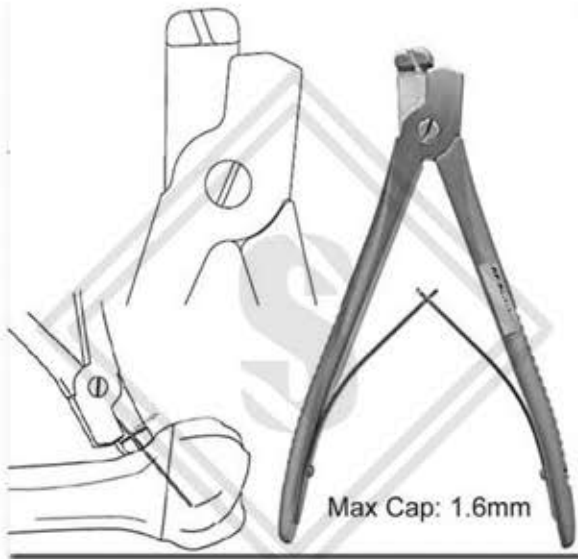

AJ-2179  
19 cm / 7 1/2"  
Gratloch Wire Bender



Max Cap:  
1.1mm  
AJ-2180  
13.5 cm / 5"  
K-Wire / Plate Bender



Max Cap:  
1.6mm  
AJ-2181  
14.5 cm / 5 1/2"  
K-Wire / Plate Bender

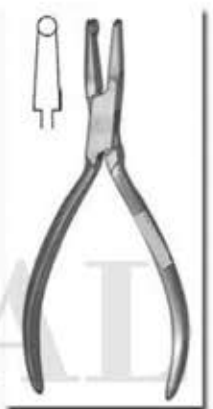

AJ-2182  
13.5 cm / 5"  
Mini Plate  
Bending Pliers

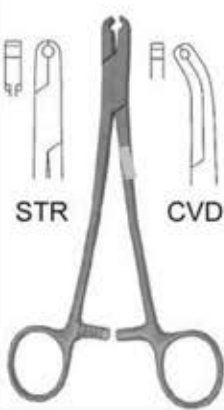

STR CVD  
AJ-2183  
18 cm / 7 1/4"  
Rod Holder  
A: 4.0mm Rod  
B: 4.76mm Rod  
C: 6.35mm Rod  
Straight or Curved

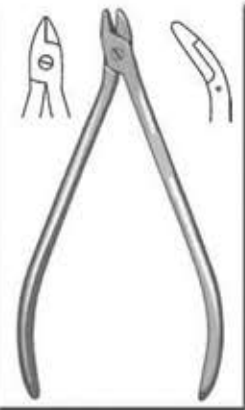

AJ-2184  
14.5 cm / 5 1/2"  
Plate Bending Pliers



AJ-2185  
16 cm / 6 1/2"  
Wire Pulling Forceps

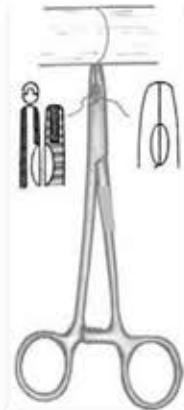

AJ-2186  
16 cm / 6 1/4"  
Wire Twister / Tightener

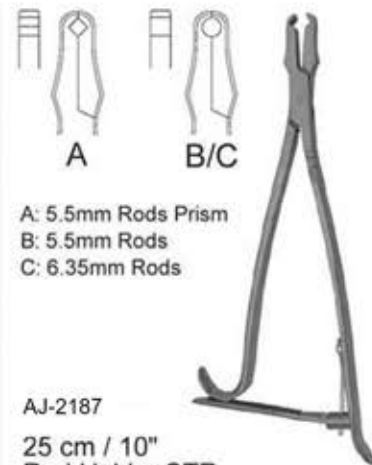

A: 5.5mm Rods Prism  
B: 5.5mm Rods  
C: 6.35mm Rods

AJ-2187  
25 cm / 10"  
Rod Holder STR



AJ-2188  
21 cm / 8 1/2"  
Rod Gripper  
Adjustable

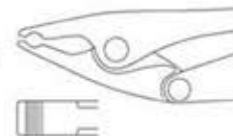



# BONE WIRE MANAGEMENT



AJ-2189  
Loute Wire Tightener (21 cm / 8 1/4")



AJ-2190  
Wire Tightener  
w/ T Handle  
11 1/2 cm / 4 1/2"



AJ-2191  
Wire Tightener 12 cm / 4 3/4"

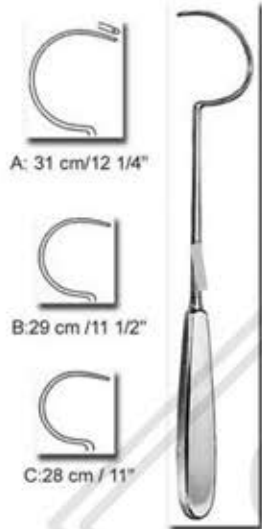

A: 31 cm / 12 1/4"  
B: 29 cm / 11 1/2"  
C: 28 cm / 11"

AJ-2192  
Demel Wire Guide



AJ-2193  
Bankert Ligature Carrier



CVD  
Crochet Hook  
Fiber Handle  
A: 18cm / 7"  
B: 23cm / 9"

AJ-2194  
Suture Passer



CVD  
Suture Hole  
Fiber Handle  
A: 18cm / 7"  
B: 23cm / 9"

AJ-2195  
Suture Passer



Suture Hole  
20cm / 8"  
A: Right Blunt  
B: Left Blunt  
C: Right Sharp  
D: Left Sharp

AJ-2196  
Deschamps Ligature Carrier

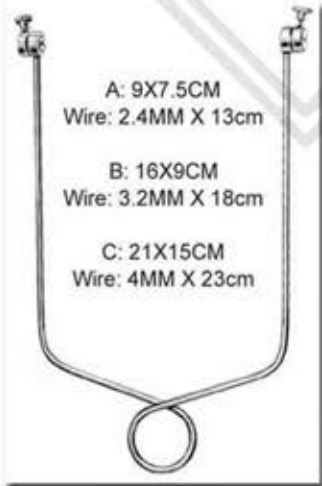

AJ-2197  
Böhler Extension  
Bow for femur & knee

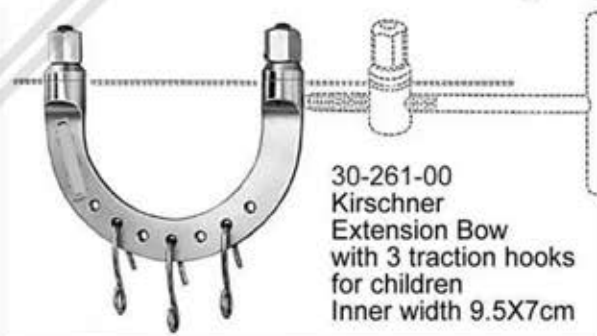

30-261-00  
Kirschner  
Extension Bow  
with 3 traction hooks  
for children  
Inner width 9.5X7cm

AJ-2198 for Wrist / Ankle 10.5X10.5cm  
AJ-2199 for Elbow 12X12cm  
AJ-2200 for Knee 15.5X15.5cm  
AJ-2201 for Femur 20X15.5cm



AJ-2202 (Kirschner) Extension Bow  
A: Small: 18.5 cm / 7 1/4"  
B: Large: 26.5 cm / 10 1/2"  
with 3 traction hooks



AJ-2203  
Wire Strainer 18.5 cm / 7 1/4"



AJ-2204  
Extension Bow  
A: 10 1/2" X 6 1/4"  
B: 7" X 4"



AJ-2205  
Fixation Discs  
for wire drills, pair

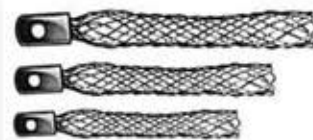

AJ-2207 . Extension Sleeve  
Small / Medium / Large



AJ-2206 Traction Hook  
for Extension Bows



TT  
Wrench 20cm / 8"



**FINGER RING CUTTING - LEAD HANDS - BIOPSY TOOLS**

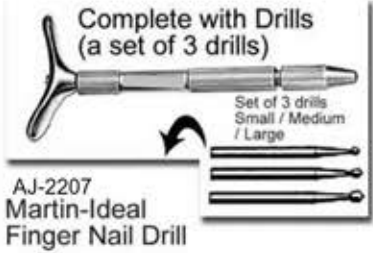

AJ-2207  
Martin-Ideal  
Finger Nail Drill



AJ-2208  
Feldheim Tourniquet  
10cm / 4"



AJ-2209  
Walton  
Finger Ring Saw  
16 cm / 6 1/4"



AJ-2210  
Finger Ring Saw  
17 cm / 6 3/4"



AJ-2211  
Radolf  
Nail Extracting Forceps

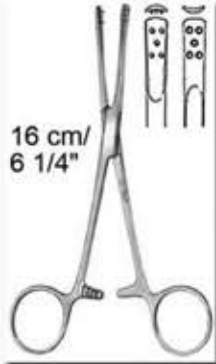

16 cm/  
6 1/4"

AJ-2212  
Nail Extracting  
Forceps



AJ-2213  
Martin Finger  
Ring Saw 18.5 cm / 6 3/4"  
Spare Blades are Available  
Separately



AJ-2213  
Finger Ring Saw Cutter Spare



AJ-2214  
Lead Hand for Kids / Adults



AJ-2215  
Lead Hand for Kids / Adults



AJ-2216  
Champy-OSU Bone Biopsy Instruments  
Consisting of trocar, a toothed trephine  
and a plunger for taking tibial and  
iliac bone grafts through a closed technique  
22 cm / 8 3/4"



AJ-2217  
Champy Cancellous Bonegraft Mill  
Outer Dia: 17mm  
Inner Dia: 16mm



AJ-2218  
Champy Bone Biopsy Instruments  
A: Outer Dia: 5mm Inner Dia: 4mm  
B: Outer Dia: 8mm Inner Dia: 7mm  
22 cm / 8 3/4"

# TAMPER - IMPACTORS - PACKERS

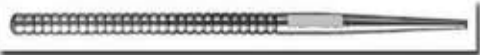

AJ-2219 15.5cm/6"  
Bone Tamper Tip Sizes:  
2-3-4-5-6-8-10mm



A: 2mm  
B: 3mm  
C: 4mm  
D: 5mm  
  
F: 6mm  
G: 8mm  
H: 9mm  
I: 10mm

AJ-2222  
Bone Tamper

Knurling Handle



AJ-2220 17cm / 6 1/2"  
Bone Impactor / Teflon Tip



AJ-2221 20cm / 8"  
Caspar Bone Tamper

Cross-Serrated  
A: 3mm  
B: 5mm  
C: 8mm



AJ-2223 21cm / 8 1/2" Lumbar / Cervical Impactor

10x4.3mm Micro Offset  
10x4.3mm Micro Lateral  
16x6.5mm Angled

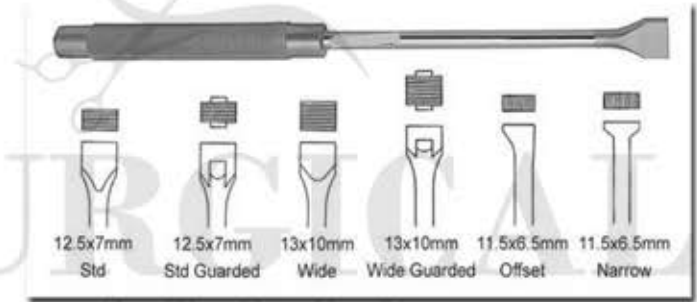

AJ-2224 21cm / 8 1/2" Lumbar / Cervical Impactor

12.5x7mm Std  
12.5x7mm Std Guarded  
13x10mm Wide  
13x10mm Wide Guarded  
11.5x6.5mm Offset  
11.5x6.5mm Narrow

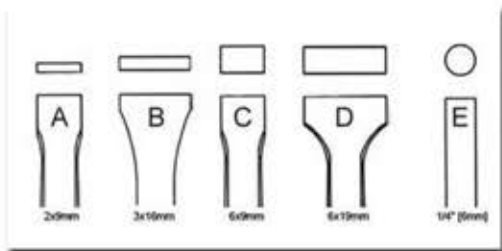

A: 2X9mm B: 3X16mm  
C: 6X9mm D: 6X19mm  
E: 6mm Dia

AJ-2225 25cm / 10"  
Bone Chip Packer



AJ-2226 43cm / 17"  
Bone Tamper



9.5mm DIA



# BONE FILES - RASPS



Putti Bone Rasp Round / Semi Round  
30cm / 11 3/4"



Bone File 28 cm / 11" w/ Hollow Handle  
Semi Round



Bone File 22 cm / 8 3/4"  
Flat / Round



Putti Bone Rasp Curved / Straight  
27cm / 10 3/4"



Bone File 24.5 cm / 9 3/4"  
w/ Hollow Handle Semi Round



Bone Rasp 22 cm / 8 3/4"  
Flat / Round



Bone File 18 cm / 7"  
Fibre Handle / Cross-Hatch



Bone File 18 cm / 7"  
Fibre Handle / Linear



Half Round

AJ-2233 Bone File 18 cm / 7"  
Fibre Handle / Straight



Half Round

AJ-2234 Bone File 18 cm / 7"  
Fibre Handle / CVD Forward



Half Round

AJ-2235 Bone File 18 cm / 7"  
Fibre Handle / CVD Backward

Diamond Coated

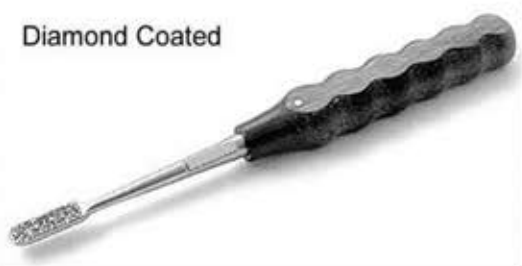

AJ-2236 Bone File 18 cm / 7"  
Fibre Handle / STR Diamond Coated

Diamond Coated



AJ-2237 Bone File 18 cm / 7"  
Fibre Handle / CVD Diamond Coated



# BONE FILES - RASPS

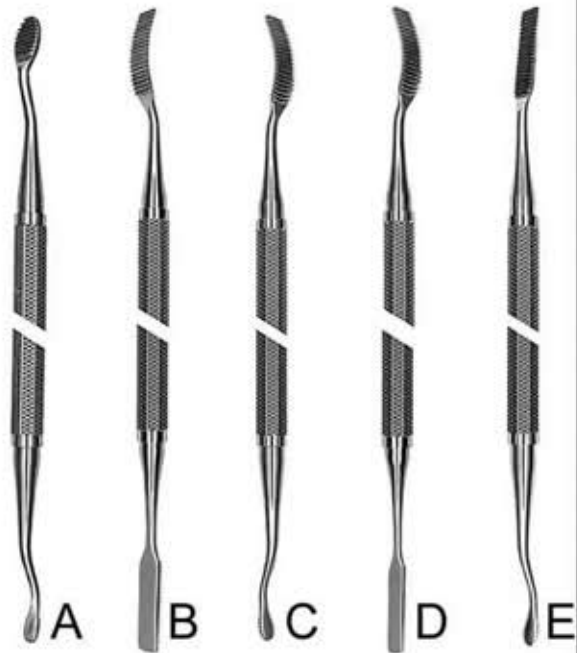

AJ-2238 A/B/C/D/E  
Miller-Colburn Bone File 18 cm / 7" Downwards Cut

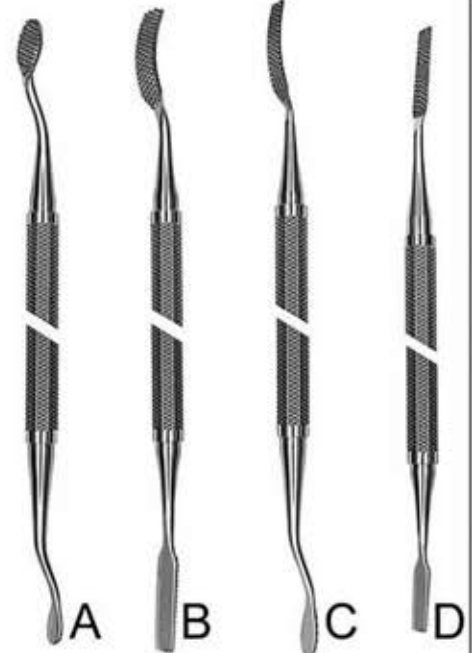

AJ-2239 A/B/C/D/  
Miller-Colburn Bone File 18 cm / 7" Cross Cut



AJ-2240  
Bone Rasp  
21 cm / 8.5"  
13mm  
Fine/Coarse  
Straight

AJ-2241  
Bone Rasp  
Joseph  
16cm / 6.25"  
8mm  
Fine Cross Serr  
Straight



AJ-2242  
Bone Rasp  
Lewis  
19cm / 7.5"  
8mm  
Straight

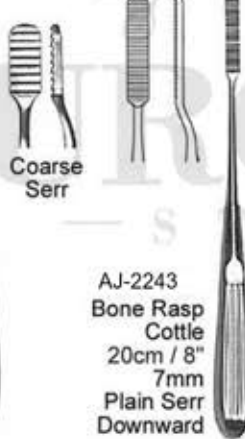

AJ-2243  
Bone Rasp  
Cottle  
20cm / 8"  
7mm  
Plain Serr  
Downward



AJ-2244  
Bone Rasp  
Maltz  
18cm / 7"  
9mm  
Plain  
Coarse Serr  
Downward

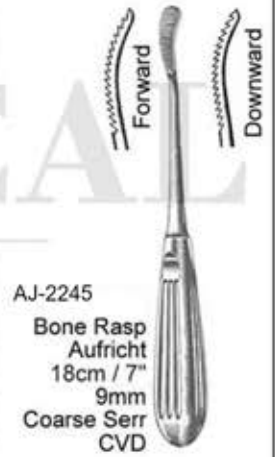

AJ-2245  
Bone Rasp  
Aufricht  
18cm / 7"  
9mm  
Coarse Serr  
CVD



AJ-2246  
Bone Rasp  
Fomon  
21 cm / 8.5"  
8mmX40mm  
Coarse Serr  
4 Sided  
Flat / Convex Baldes



AJ-2247  
Bone Rasp  
Fomon  
21 cm / 8.5"  
8mmX40mm  
Fine Serr  
4 Sided  
Flat / Convex Blades



AJ-2248  
Bone Rasp  
Kleinert Kurtz  
21 cm / 8.5"  
8mmX45mm  
Fine/Coarse Serr  
4 Sided  
Flat / Convex Blades



AJ-2249  
Bone File / Rasp  
21 cm / 8.5"  
18mm  
Fine / Coarse Serr

# RETRACTORS - BONE LEVERS



AJ-2250 Bone Lever  
16 cm / 6 1/4"

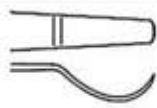

AJ-2252 Hohman, Mini Bone Lever  
16 cm / 6 1/4" 14 mm tip

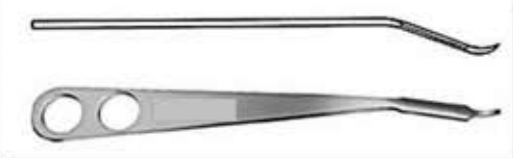

AJ-2255 Hohmann Bone Lever  
22 cm / 8 3/4" 8 mm Tip narrow tip

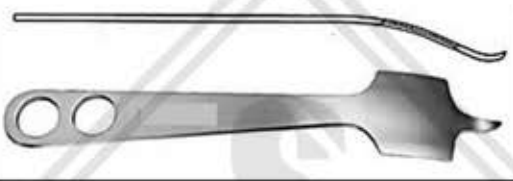

AJ-2257 Hohmann Bone Lever  
23.5 cm / 9 1/4" 43 mm Tip narrow tip



AJ-2260 Lange-Hohmann Bone Lever  
25 cm / 9 3/4" 22mm Tip wide tip with groove



AJ-2261 Hohmann Bone Lever 27.5 cm / 10 3/4"  
24mm Tip wide, round tip



Sizes Available  
A: 75X30mm  
B: 100X30mm

AJ-2266 A / B Taylor Spinal Retractor  
16 cm/6 1/4" pointed end



AJ-2251 Hohman, Mini Bone Lever 16 cm / 6 1/4" 6mm tip



AJ-2253 Hohman, Mini Bone Lever 16 cm / 6 1/4" 8 mm tip

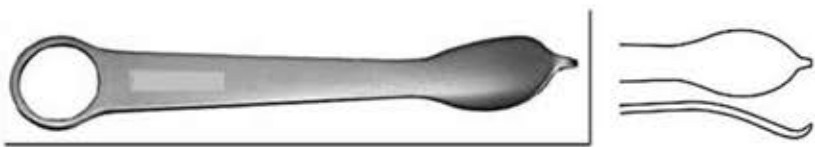

AJ-2254 Hohman, Mini Bone Lever 12 cm / 4 3/4" 14 mm tip



AJ-2258 Hohmann Bone Lever  
13cm/5" A:3mm B:5mm C:7mm



AJ-2256 Hohmann Bone Lever  
23.5 cm / 9 1/4" 18 mm Tip narrow tip



AJ-2259 Hohmann Bone Lever 29 cm / 11 1/2"  
35mm Tip wide tip

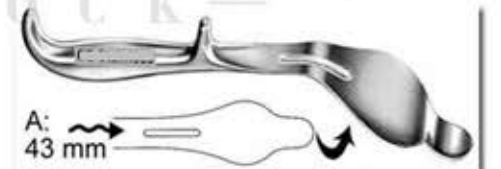

AJ-2263 Bennett Bone Lever  
24 cm / 9 1/2"



AJ-2262

Hohmann Bone Lever 25 cm / 9 3/4" 70 mm Tip narrow tip



AJ-2264

Hohmann Bone Lever  
23.5 cm / 9 1/4" 43mm Tip narrow tip



AJ-2266 Hohmann Bone Lever 25.5 cm / 10"  
22mm Tip wide tip



AJ-2265 Blount Knee Retractor  
26.5 cm / 10 1/2" blunt



Blount Knee Retractor  
26.5 cm / 10 1/2"



AJ-2267 Blount Knee Retractor  
17.5 cm / 7"

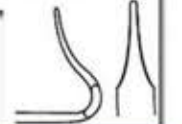



# RETRACTORS - BONE LEVERS



AJ-2268 Fukuda Retractor  
19 cm / 7 1/2" T Handle



30-336-28 Browne - Deltoid Retractor  
28 cm / 11" T Handle w/ Ring



AJ-2269 Humeral Head Retractor  
18 cm / 7" Strong Curved

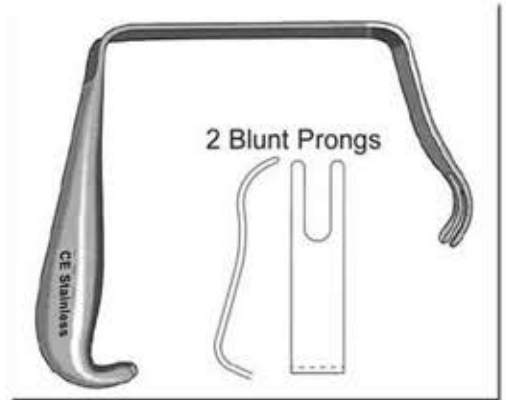

AJ-2270 Bristow / Bankart  
Humeral Retractor  
18 cm / 7"



AJ-2271 Capsule Retractor  
25 cm / 10"



AJ-2272 Capsule Retractor  
25 cm / 10"

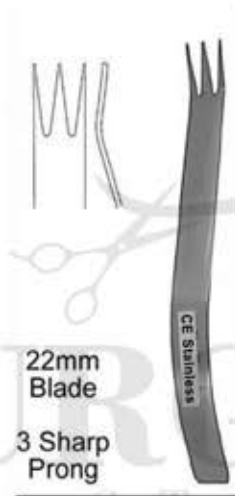

AJ-2273 Capsule Retractor  
25 cm / 10"

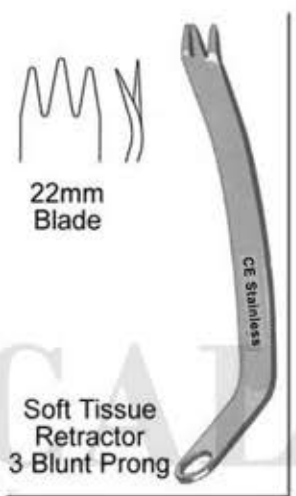

AJ-2274 Bristow/Bankart  
19 cm / 7 1/2"



AJ-2275 Blade Retractor  
19 cm / 7 1/2"

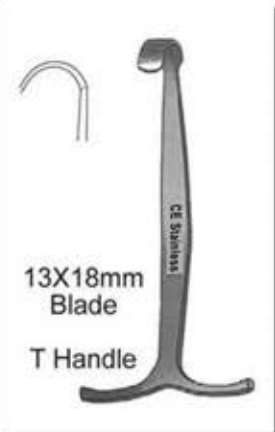

AJ-2276 Smillie Retractor  
13cm / 5"



AJ-2277 Smillie Retractor  
14cm / 5 1/2"



AJ-2278 Smillie Retractor  
Angled Blade 14cm / 5 1/2"



AJ-2279 Z Knee Retractor  
15 cm / 6"



AJ-2280 Knee Retractor  
22 cm / 8 1/2" Ring Handle

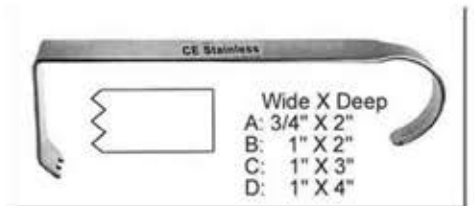

AJ-2281 Hibbs Retractor  
24 cm / 9 1/2" Sharp Teeth



# RETRACTORS - BONE LEVERS

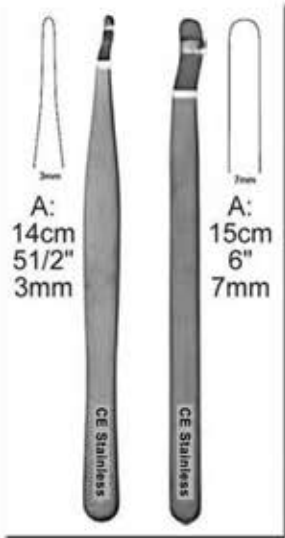

AJ-2282  
Hayes Retractor

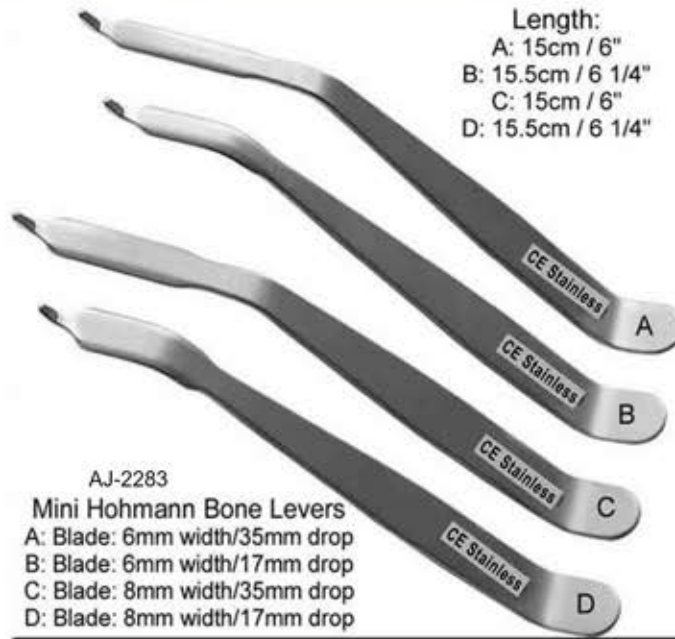

Length:  
A: 15cm / 6"  
B: 15.5cm / 6 1/4"  
C: 15cm / 6"  
D: 15.5cm / 6 1/4"

AJ-2283  
Mini Hohmann Bone Levers  
A: Blade: 6mm width/35mm drop  
B: Blade: 6mm width/17mm drop  
C: Blade: 8mm width/35mm drop  
D: Blade: 8mm width/17mm drop

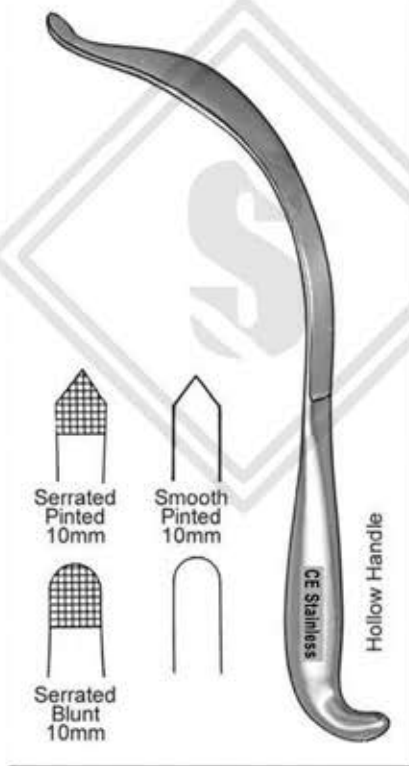
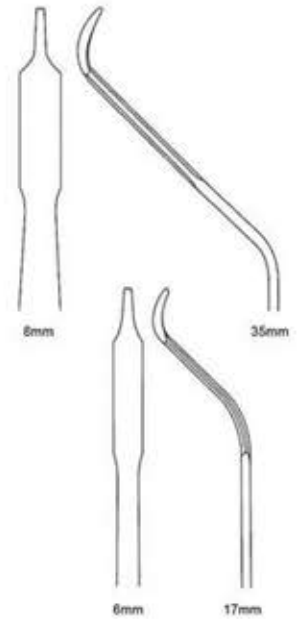

AJ-2284  
Aufranc Cobra Retractor  
A: 26cm / 10 1/2"



AJ-2285  
Aufranc Cobra Retractor  
A: 27.5cm / 11"

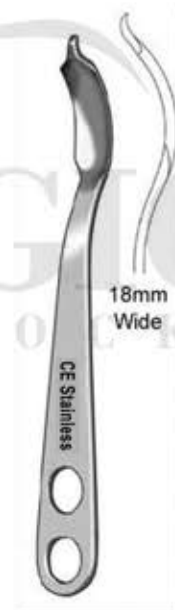

AJ-2286  
Humeral Head Retractor  
23cm / 9"

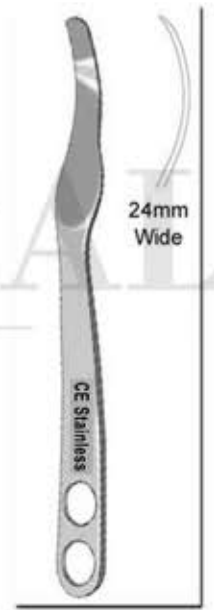

AJ-2287  
Pelvic Retractor  
Single Prong  
A: 26cm / 10 1/2"



AJ-2288  
Murphy Bone Skid  
30cm / 12"

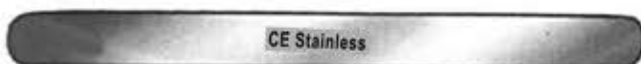

AJ-2289  
Ribbon Retractor Malleable  
30cm / 12"

A: 6" X 6mm  
B: 6" X 12mm  
C: 6" X 16mm  
D: 6" X 19mm  
E: 7 1/2" X 25mm

F: 8" X 6mm  
G: 8" X 10mm  
H: 8" X 12mm  
I: 8" X 16mm  
J: 8" X 19mm

K: 13" X 19mm  
L: 13" X 30mm  
M: 13" X 38mm  
N: 13" X 45mm  
O: 13" X 50mm  
P: 13" X 65mm  
Q: 13" X 75mm

## Sizes Available

# RETRACTORS - BONE LEVERS

AJ-2290  
St. Mark's Pelvic Retractor  
Angled Blade

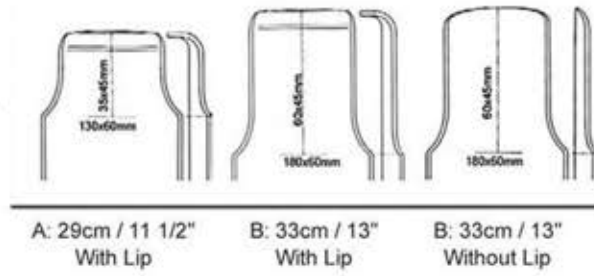

- A: 22mm Blade  
2 Finger Rings Long Round → 
- B: 22mm Blade  
1 Finger Ring Short Round → 



# CHISELS - GOUGES - OSTEOTOMES

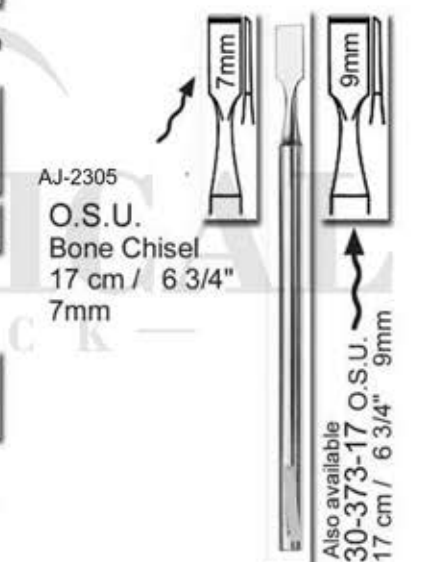
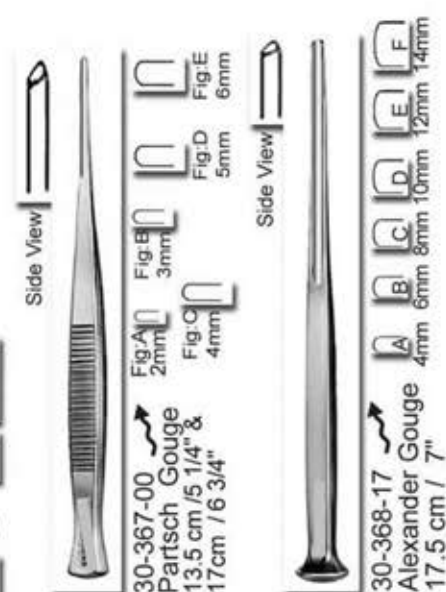
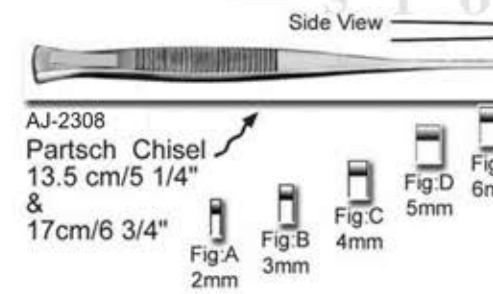
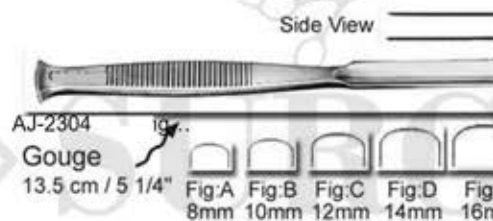
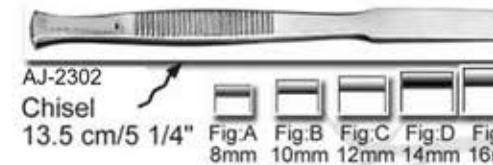
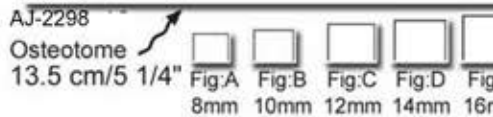
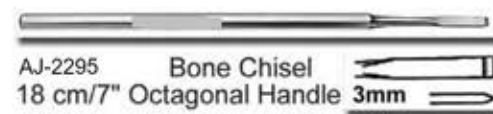
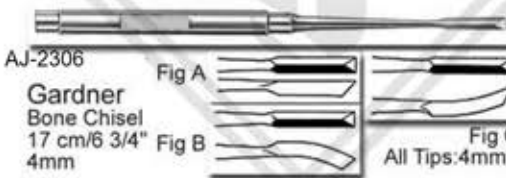
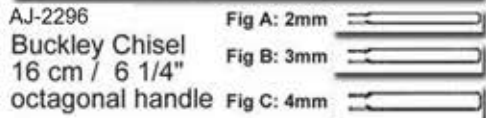

**TIP**

Three sizes in Lambotte Mini Osteotome (see below)

Available Tip Sizes: 2mm / 3mm / 4mm / 6mm / 8mm / 10mm / 12mm / 15mm

Side View

AJ-2311 (12.5 cm / 5") Lambotte, Mini Osteotome

AJ-2312 (17 cm / 6 3/4") Lambotte, Mini Osteotome  
3mm / 4mm / 6mm / 8mm / 10mm / 12mm / 15mm

AJ-2313 (24 cm / 9 1/2") Lambotte, Osteotome  
15mm / 20mm / 25mm / 30mm / 38mm / 44mm / 50mm

Available in  
15mm  
20mm  
25mm  
30mm  
38mm  
44mm  
50mm

AJ-2310  
Lambotte,  
Osteotome  
24 cm / 9 1/2"

**Other Lambotte Mini Osteotomes sizes / Tips**

For Image, please see photo of above Osteotome.

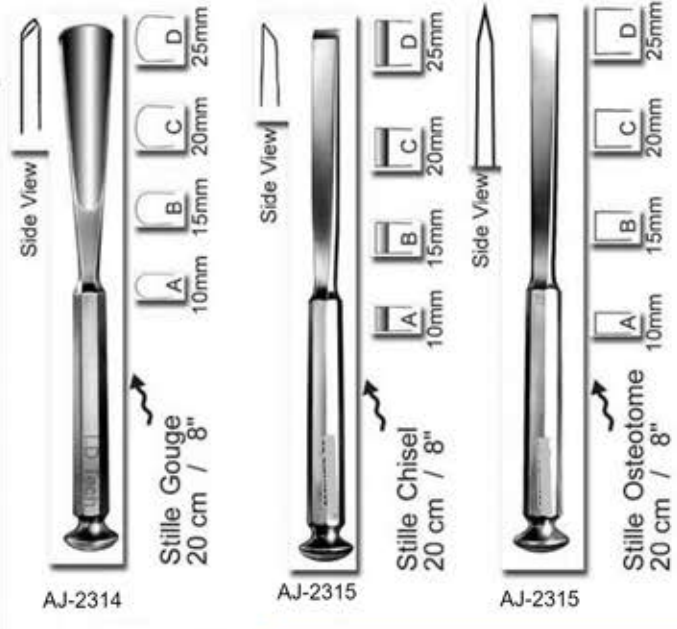



# CHISELS - GOUGES - OSTEOTOMES

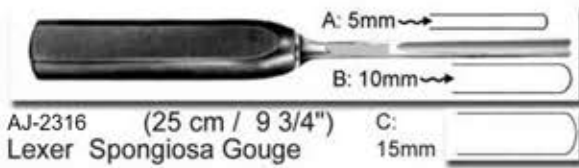

AJ-2316 (25 cm / 9 3/4")  
Lexer Spongiosa Gouge

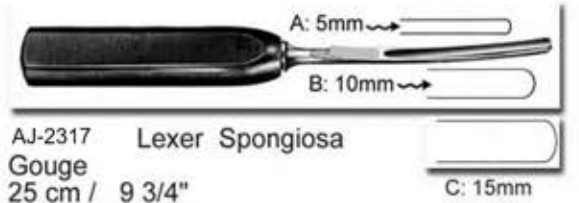

AJ-2317 Lexer Spongiosa  
Gouge  
25 cm / 9 3/4"

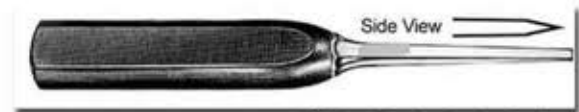

AJ-2320  
Lexer, Mini Osteotome  
18.5 cm / 7 1/4"



AJ-2322  
Lexer, Mini Gouge  
18.5 cm / 7 1/4"



AJ-2324 Lexer,  
Osteotome  
22 cm / 8 3/4"



AJ-2327  
Lexer, Gouge  
22 cm / 8 3/4"



AJ-2329  
Vickers Spongiosa Gouge  
18 cm / 7"



AJ-2331 US Army Chisel 18 cm / 7"



AJ-2333 US Army Osteotome 18 cm / 7"



A: 6mm B: 12mm C: 14mm D: 18mm



AJ-2318  
Smith-Petersen  
Osteotome  
20.5 cm / 8"

Available Tips  
6mm  
9mm  
13mm  
16mm  
19mm  
25mm  
32mm

TIP

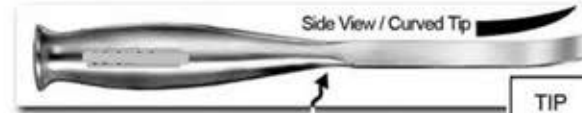

AJ-2319 Smith-Petersen  
Osteotome  
20.5 cm / 8"

TIP

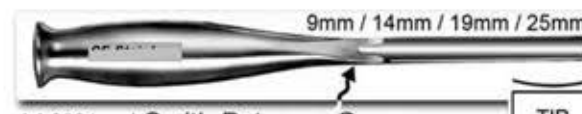

AJ-2321 Smith-Petersen Gouge  
20.5 cm / 8"

TIP



AJ-2323 Smith-Petersen Gouge  
20.5 cm / 8"

TIP

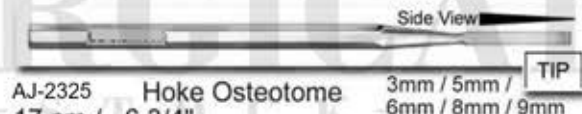

AJ-2325 Hoke Osteotome  
17 cm / 6 3/4"

TIP



AJ-2326 Hibbs Osteotome  
24.5 cm / 9 3/4"

TIP



AJ-2328 Hibbs Chisel  
24.5 cm / 9 3/4"

TIP



AJ-2330 Hibbs Gouge  
24.5 cm / 9 3/4"

TIP



AJ-2332 Sheehan Osteotome 16cm / 6 1/2"



AJ-2332 Sheehan Osteotome 16cm / 6 1/2"

# CHISELS - GOUGES - OSTEOTOMES

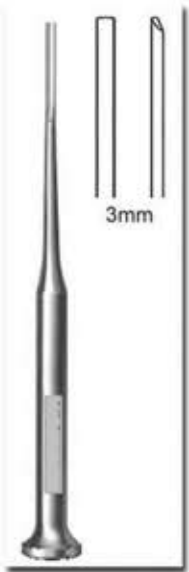

AJ-2334

Shoulder Penetrating Gouge 21cm/8 1/2"



AJ-2335

Swan Neck Gouge 23cm/9"

Handle Solid Hexagonal

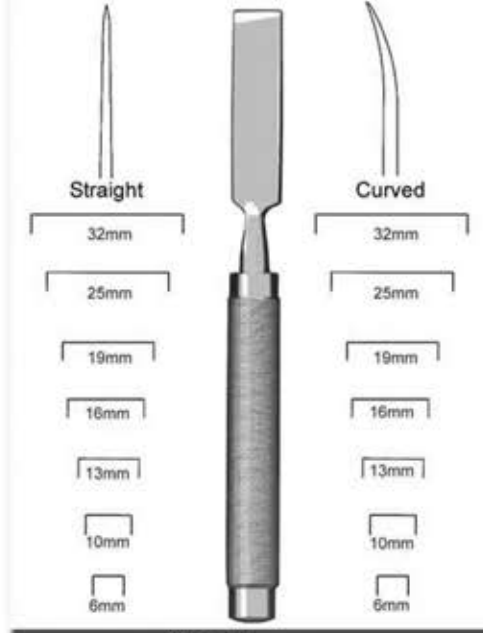

AJ-2336

Cobb Osteotome 28cm/11"

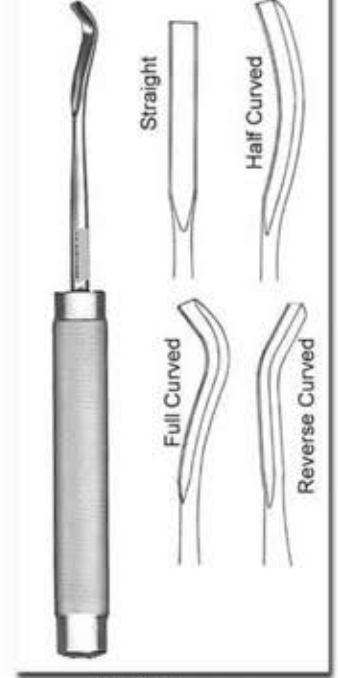

AJ-2337

Cobb Gouge 28cm/11"

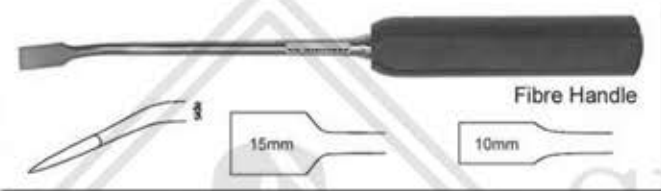

AJ-2338

Lexer Osteotome Angled / 28cm/11"

Fibre Handle



AJ-2339

Cinelli Osteotome 15.5cm/6 1/2"

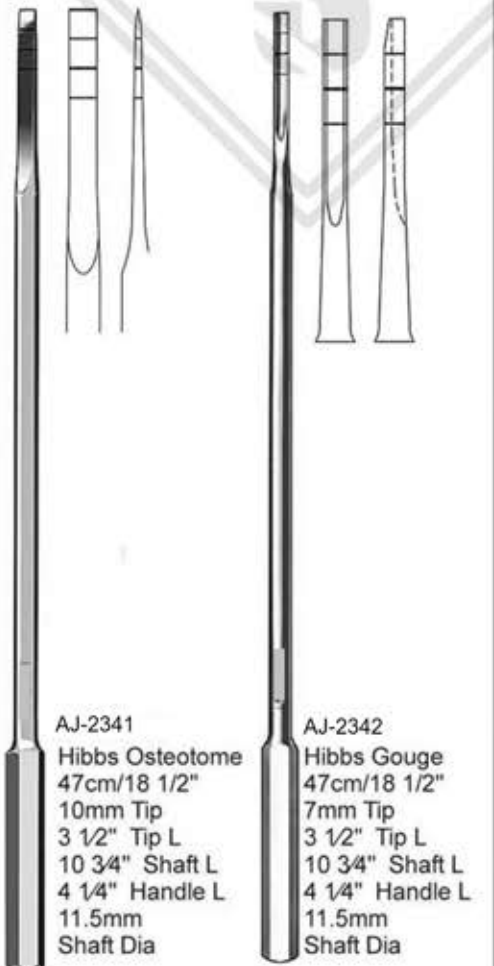

AJ-2341

Hibbs Osteotome 47cm/18 1/2"  
10mm Tip  
3 1/2" Tip L  
10 3/4" Shaft L  
4 1/4" Handle L  
11.5mm Shaft Dia

AJ-2342

Hibbs Gouge 47cm/18 1/2"  
7mm Tip  
3 1/2" Tip L  
10 3/4" Shaft L  
4 1/4" Handle L  
11.5mm Shaft Dia



AJ-2343

Spinal Fusion Gouge 24cm/9 1/2"  
6mm Tip

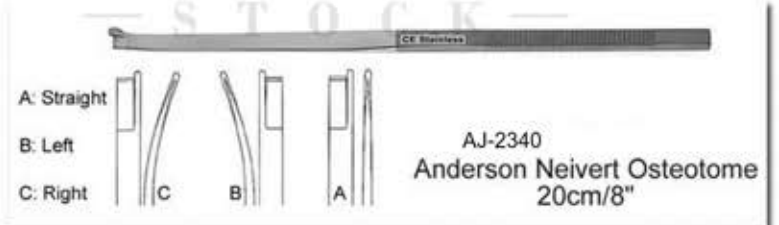

AJ-2340 Anderson Neivert Osteotome 20cm/8"

Set Includes:  
5 Chisels  
5/10/15/25mm  
5 Osteotomes  
5/10/15/25mm  
3 Gouges  
50/60/70mm Radius  
1 Handle Fibre  
1 Key

AJ-2344  
Chisel Handle Fibre w/Chisel - Osteotome - Gouge Blades  
18.5cm/7 1/4"







# BONE CURETTES

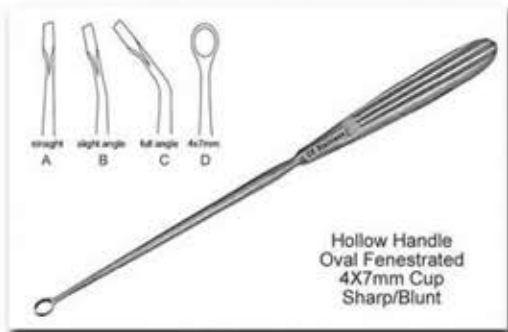
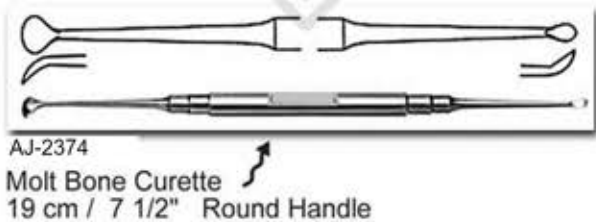
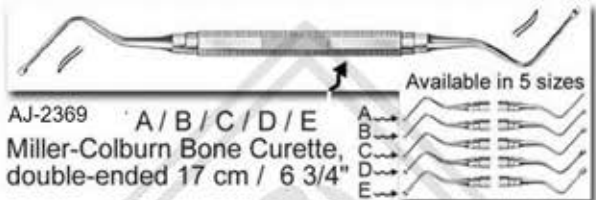
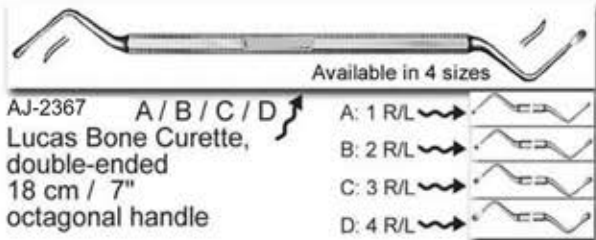
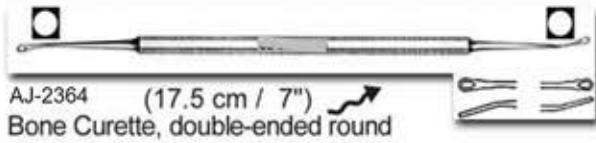

AJ-2376  
Semmes Ring Curette  
23 cm / 9"



AJ-2377  
Scoville Curette  
25 cm / 10"



AJ-2378  
Ring Curette  
A: 25 cm / 10" #0 6mm Cup  
B: 25 cm / 10" #2 8mm Cup  
C: 26 cm / 10 1/2" #6 14mm Cup  
D: 28 cm / 11 1/2" #0 6mm Cup  
E: 28 cm / 11 1/2" #2 8mm Cup  
F: 30 cm / 12 1/2" #6 14mm Cup

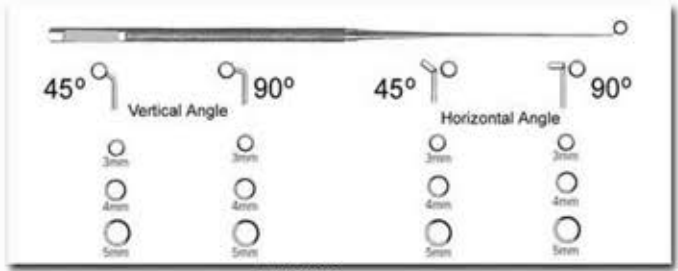

AJ-2366  
Ray Pituitary Curette 18 cm / 7 1/2"

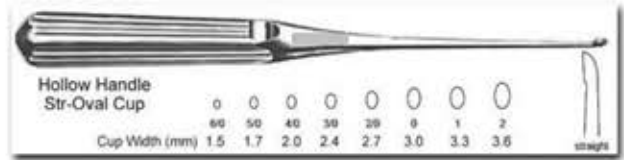

AJ-2368  
Lempert Curette 18 cm / 7 1/2"

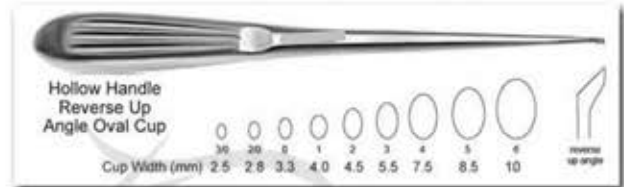

AJ-2370  
Epstein Curette 18 cm / 7 1/2"



AJ-2372  
Bushe Curette 25 cm / 10"

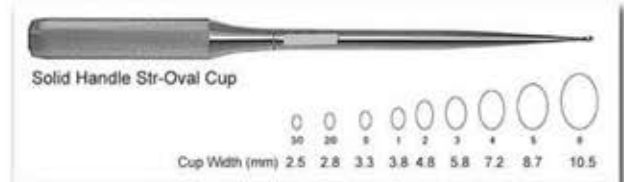

AJ-2375  
Spinal Fusion Curette 28 cm / 11"

# BONE CURETTES

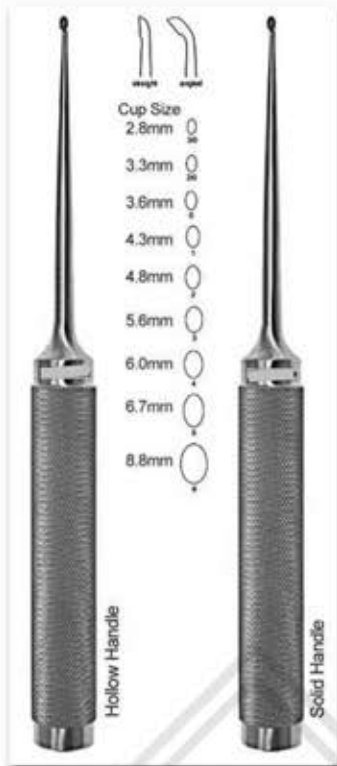

AJ-2379  
Cobb Curette Oval Cups  
28 cm / 11"



AJ-2380  
Cobb Curette Oval Cups  
28 cm / 11"



AJ-2381  
Syperet Curette Long Delicate Shaft



AJ-2382  
Cone Ring Curette  
23 cm / 9"



- A: Straight 8mm Sharp/Blunt
- B: Straight 11mm Sharp/Blunt
- C: Angled 8mm Sharp/Sharp
- D: Angled 11mm Sharp/Sharp
- E: Angled 8mm Sharp/Sharp Right Cvd
- F: Angled 11mm Sharp/Sharp Right Cvd
- G: Angled 8mm Sharp/Sharp Left Cvd
- H: Angled 11mm Sharp/Sharp Left Cvd

AJ-2383 Zielke Ring Curette 34 cm / 13 1/2" TEFLON Handle

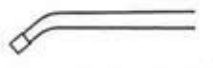
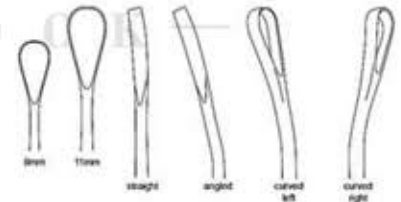

17" Angled 40°  
3mm Diameter  
2.7" Tip Length  
9.3" Shaft Length  
5" Handle Length  
.285 (7.2mm)  
Shaft Diameter



AJ-2384 Cone Ring Curette Endoscopic Fibre Handle



20" Angled 30°  
6mm Diameter  
3 1/2" Tip Length  
10" Shaft Length  
6 1/2" Handle Length  
.45" (11.5mm)  
Shaft Diameter

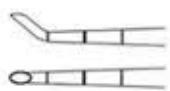

17" Reverse  
Angled 40°  
3mm x 6mm cup  
2.7" Tip Length  
9.3" Shaft Length  
5" Handle Length  
.285 (7.2mm)  
Shaft Diameter



AJ-2385 Epstein Curette Endoscopic Fibre Handle

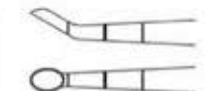

20" Reverse  
Angled 30°  
6mm x 9mm cup  
3 1/2" Tip Length  
10" Shaft Length  
6 1/2" Handle Length  
.45 (7.2mm)  
Shaft Diameter



# ELEVATORS

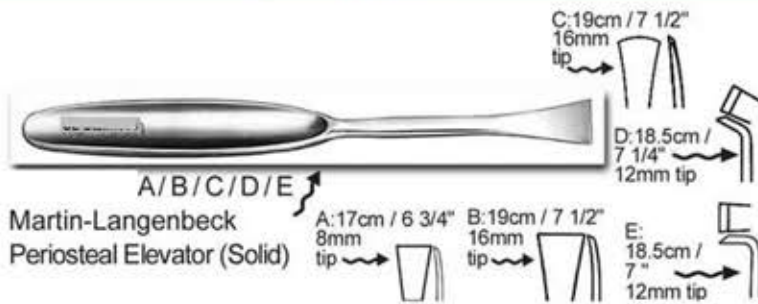

Martin-Langenbeck Periosteal Elevator (Solid)

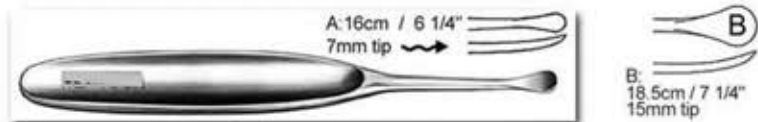

Martin-Langenbeck Periosteal Elevator (Solid)

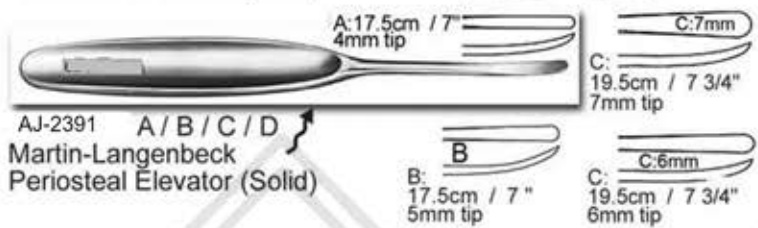

AJ-2391 Martin-Langenbeck Periosteal Elevator (Solid)

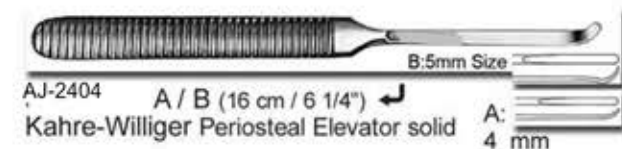

Farabeuf Periosteal Elevator  
 15 cm / 6" with hollow handle

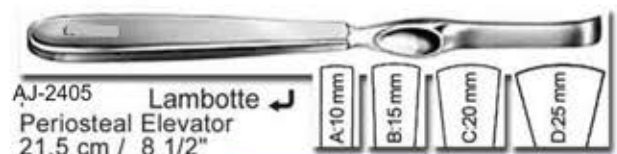
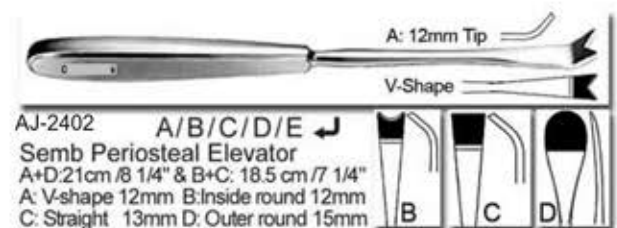
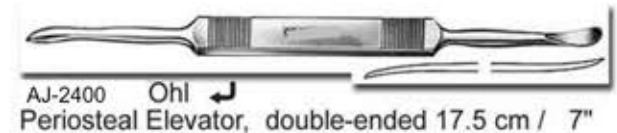
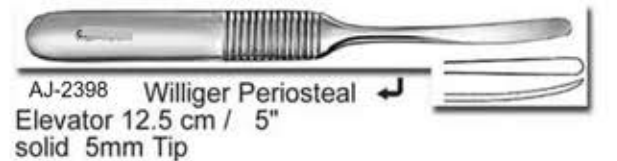
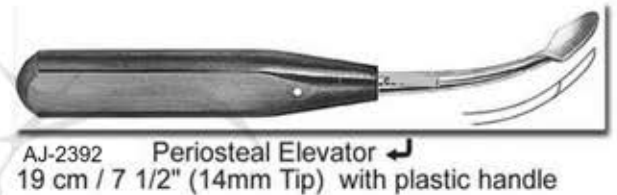



# ELEVATORS



Periosteal Elevator  
20 cm / 8" with plastic handle

19 mm Tip



A / B Periosteal Elevator  
17 cm / 6 3/4" with hollow handle

B: 8 mm Tip

A: 6 mm Tip

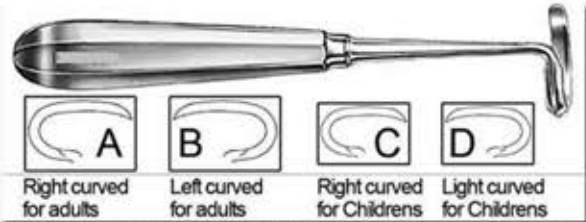

A / B / C / D Doyen Rib Raspatory  
17.5 cm / 7" Rib Raspatories with hollow handle



AJ-2412 West Periosteal Elevator,  
double-ended 18.5 cm / 7 1/4"  
octagonal handle



AJ-2414 Williger Elevator  
17 cm / 6 3/4" 7mm tip

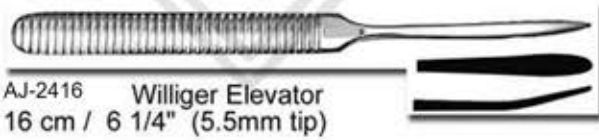

AJ-2416 Williger Elevator  
16 cm / 6 1/4" (5.5mm tip)



AJ-2418 Elevator  
17 cm / 6 3/4" Light weight

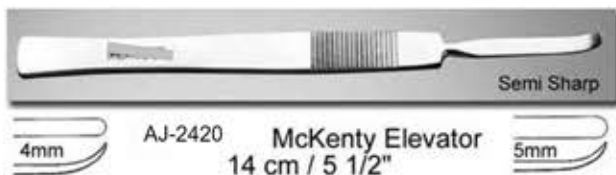

AJ-2420 McKenty Elevator  
14 cm / 5 1/2"

Semi Sharp

4mm

5mm



2mm X 3mm Sharp End



AJ-2422 Kleinert Kutz  
Elevator 14 cm / 5 1/2"



AJ-2424 Penfield Elevator Endoscopic  
38 cm / 15" 5mm Semi Sharp / 1X10mm Blunt Hook

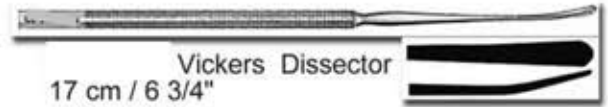

Vickers Dissector  
17 cm / 6 3/4"

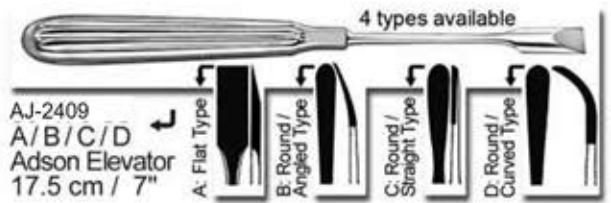

AJ-2409 A/B/C/D Adson Elevator  
17.5 cm / 7"

4 types available

A: Flat Type

B: Round/Angled Type

C: Round/Straight Type

D: Round/Curved Type

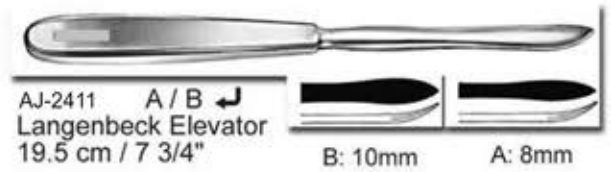

AJ-2411 A/B Langenbeck Elevator  
19.5 cm / 7 3/4"

B: 10mm

A: 8mm

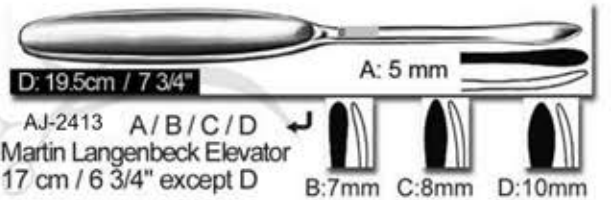

AJ-2413 A/B/C/D Martin Langenbeck Elevator  
17 cm / 6 3/4" except D

B:7mm

C:8mm

D:10mm



AJ-2415 Phalangeal Elevator  
16 cm / 6 1/4"

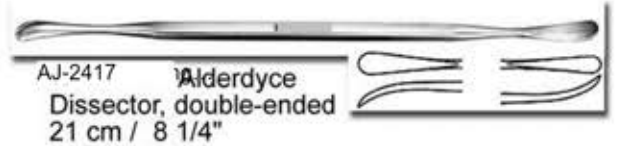

AJ-2417 Alderdyce Dissector, double-ended  
21 cm / 8 1/4"

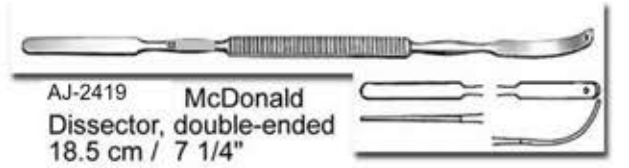

AJ-2419 McDonald Dissector, double-ended  
18.5 cm / 7 1/4"



AJ-2421 Freer Elevator  
19 cm / 7 1/2"



AJ-2423 Smithwick Hook and Dissector  
30 cm / 12" 5mm Semi Sharp / 1X10mm Blunt Hook

# ELEVATORS

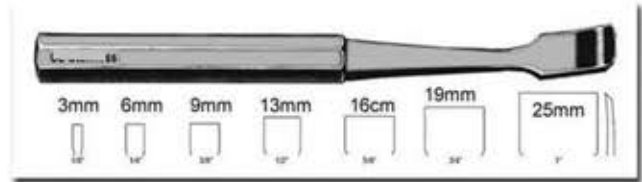

AJ-2425 Key Elevator 19 cm / 7 1/2" Sharp Edge



AJ-2426 Sayre Elevator 16 cm / 6 1/2"  
A: Sharp / Blunt B: Blunt / Blunt



AJ-2428 Kirrission Periosteal Respiratory 17 cm / 6 3/4"

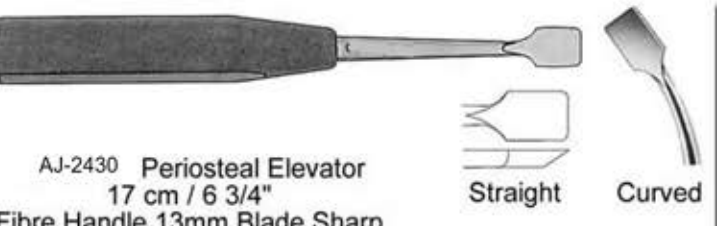

AJ-2430 Periosteal Elevator  
17 cm / 6 3/4"  
Fibre Handle 13mm Blade Sharp



AJ-2432 Crego Periosteal Elevator  
19 cm / 7 3/4" Sharp  
A: 14mm Full Curves B: 14mm Slight Curves  
C: 7mm Full Curves D: 7mm Slight Curves



AJ-2427 Sedilot Elevator 18 cm / 7" Sharp Edge



AJ-2429 Alexander  
Periosteal Respiratory  
20 cm / 8" / 12mm Sharp

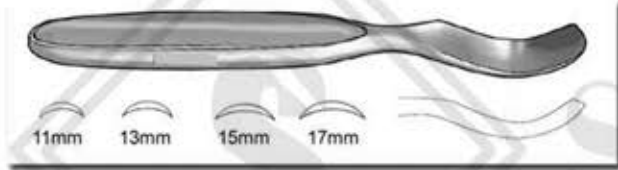

AJ-2431 McGlamry Metatarsal Elevator  
16 cm / 6 1/2" Sharp



AJ-2433 Chandler Elevator Blunt

A: 19cm / 7 1/2" 13mm B: 20cm / 8" 19mm  
C: 23cm / 9" 25mm D: 25.5cm / 10" 30mm



AJ-2434 Darrach Elevator Blunt

Small  
A: 26cm / 10 1/4" 13mm Width at Tip  
Medium  
B: 26cm / 10 1/4" 20mm Width at Tip  
Large  
C: 35cm / 13 3/4" 25mm Width at Tip

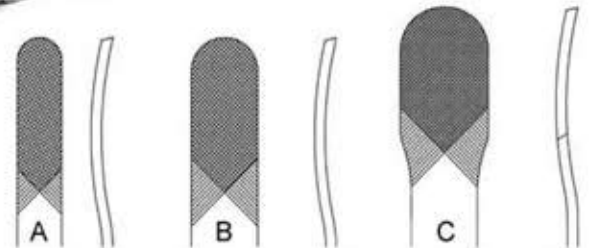
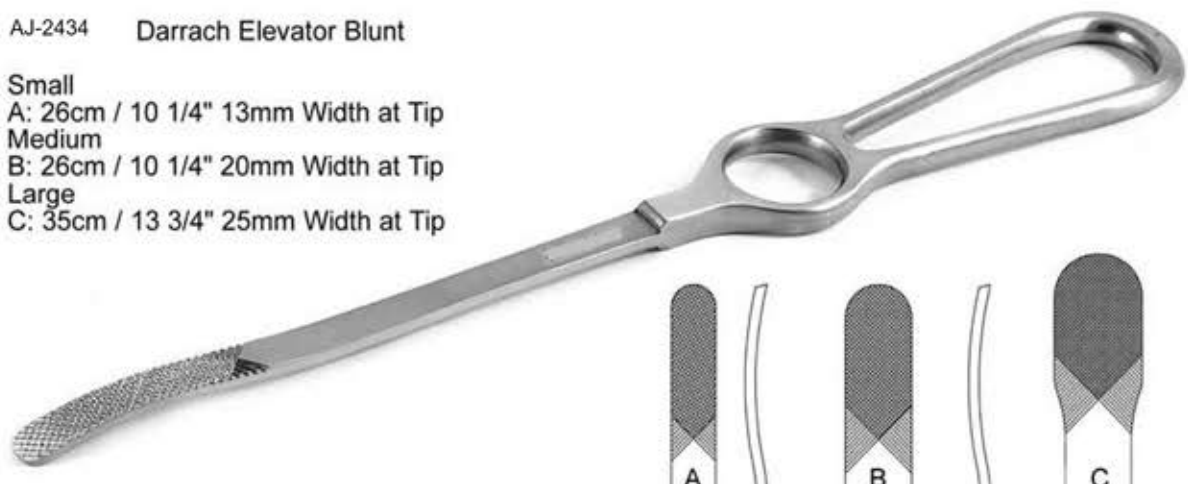

# ELEVATORS



AJ-2435 Cobb Spinal Elevator Sharp  
24cm / 9 1/2" Hexa Handle

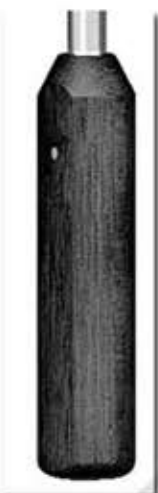

Also Available  
in Fibre Handle

with Same  
Sizes  
of Blades

AJ-2436  
25cm / 10"

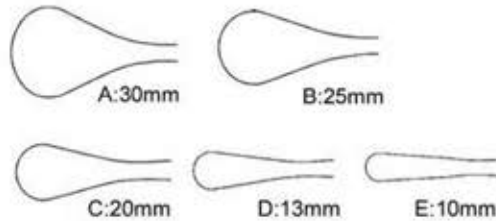

AJ-2437 Cobb Spinal Elevator Sharp  
28cm / 11" Knurled Handle



AJ-2438 Cobb Elevator Endoscopic Sharp / Fibre Handle



AJ-2439 Rib Elevator Endoscopic Sharp / Fibre Handle  
43cm / 17" - 9mm Tip Radius - 4" Tip Length  
8" Shaft Length - 5" Handle Length  
11.5mm Shaft Dia

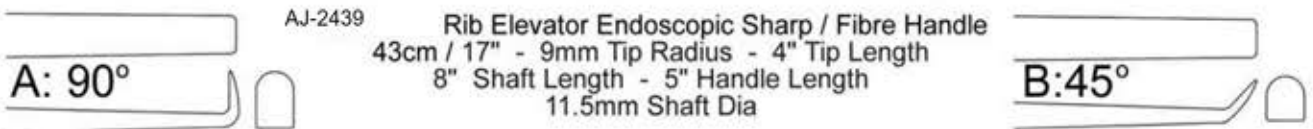

AJ-2440 Wagner Elevator Sharp / Fibre Handle  
33cm / 13"  
A: 8mm Wide    B: 17mm Wide

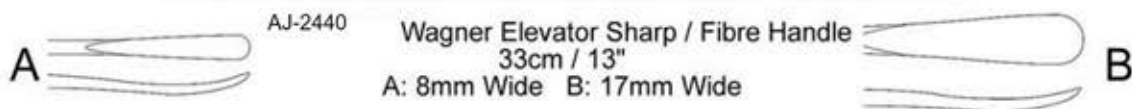



# BONE MALLET

**Note: Handle Shown In Dark Colors are Made of FIBRE Material**

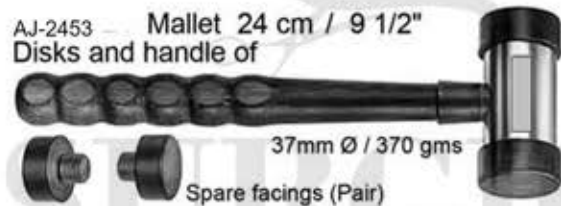
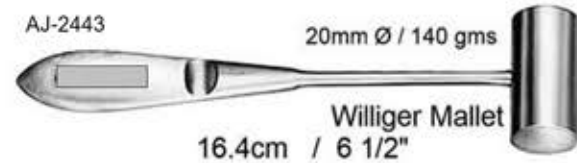
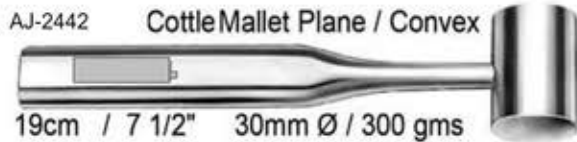
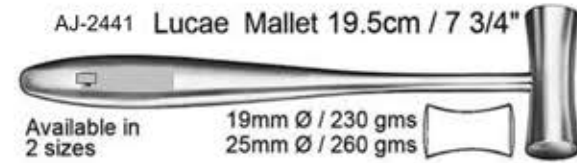

# BONE MALLET

**Note: Handle Shown In Dark Colors are Made of FIBRE Material**



AJ-2461  
Kirk Mallet 20cm / 8"  
Head Dia 38mm/Weight: 1 lb. 4 oz. (570 grams)



Head Weight: 7 oz (200 grams)

AJ-2462 Gerzog Mallet 19cm / 7 1/2"  
Head Dia 25mm/Weight 10 oz (285 grams)

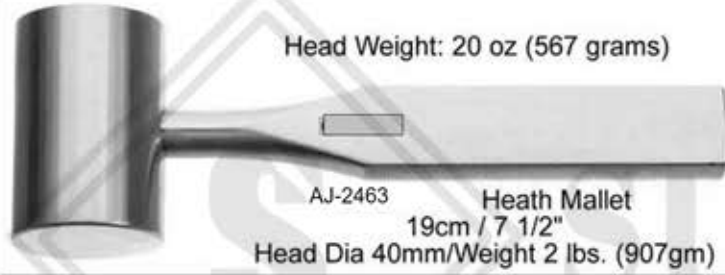

Head Weight: 20 oz (567 grams)

AJ-2463 Heath Mallet  
19cm / 7 1/2"  
Head Dia 40mm/Weight 2 lbs. (907gm)

Head Weight: 20 oz (567 grams)



AJ-2466 Heath Mallet, SS  
18cm / 7" Solid Frame Handle  
Head Dia 40mm/Weight 36 oz. (1020gm)



AJ-2468 All Fibre Mallet 24cm / 9 1/2"  
Head Dia 80X60mm Weight 14oz. (397gm)



AJ-2464 Cloward Mallet  
19cm / 7 1/2"  
Head Dia 20mm  
Weight 8oz. (227gm)

Fibre Handle



AJ-2465 Hajek Mallet  
20cm / 8"  
Head Dia 27mm  
Weight 7oz. (198gm)



Fibre Handle

AJ-2467 Narrow Tip Mallet 20cm / 8"  
Head Dia 7mm Weight 6oz. (170gm)



30-535-23 Fibre Handle Mallet 23cm / 9"  
Head Dia 30mm/Weight 12 oz. (340gm)

Also Available in:  
Head Dia 35mm/Weight 1lb 40 oz. (570gm)  
Head Dia 40mm/Weight 1lb 90 oz. (708gm)



AJ-2469 He-Man Mallet 28cm / 11"  
Head Dia 38mm / 24mm  
Weight 2lb (906gm)



# TENDON - CARTILAGE - MENISCUS TOOLS

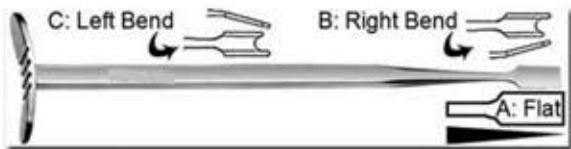

AJ-2470 Smillie Meniscus Knife 18 cm / 7"



AJ-2471 Meniscus Knife 18 cm / 7"



AJ-2472 A / B Neff Meniscus Knife 22 cm / 8 3/4"



AJ-2473 A / B Salenius Meniscus Knife 21 cm / 8 1/4" A: Right / B: Left



AJ-2474 Bunnell Tendon Stripper 15 cm / 6"



AJ-2475 Tendon Stripper 23 cm / 9" Flexible shaft

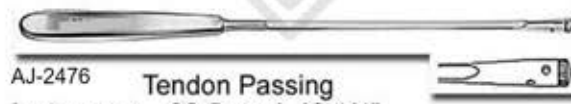

AJ-2476 Tendon Passing Instrument 33.5 cm / 13 1/4"

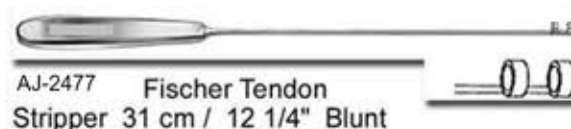

AJ-2477 Fischer Tendon Stripper 31 cm / 12 1/4" Blunt



AJ-2478 Tendon Stripper 3 / 4 / 5 / 6mm A: 28.5 cm / 11 1/4" B: 60 cm / 24"



AJ-2479 Bunnell Tendon Passer 23 cm / 9" Malleable



AJ-2480 Tendon Stripper 40 cm / 16" Fibre Handle



AJ-2481 Lowe Breck Cartilage Knife 25 cm / 10" Str Edge-Cvd Blade w/ Guards

AJ-2482 Downing Cartilage Knife 25 cm / 10" Concave Edge Cvd Blade w/ Guards



AJ-2483 Martin Cartilage Scissors 20cm / 8"

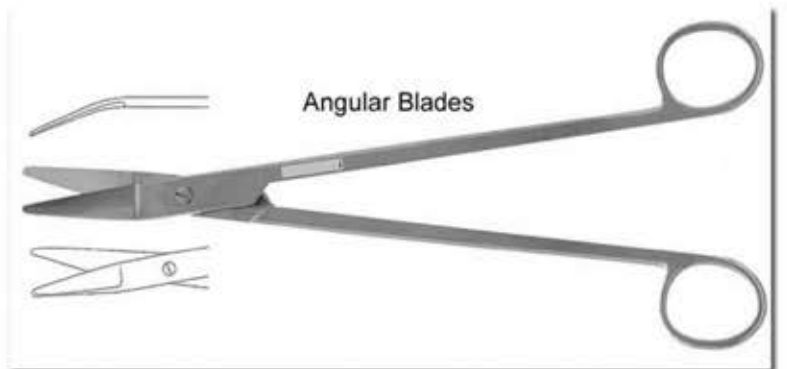

AJ-2484 Mueller Capsule Scissors 24cm / 9 1/2"



# TENDON INSTRUMENTS

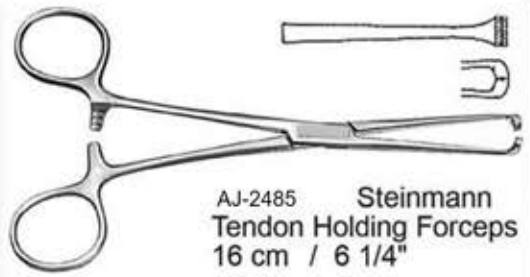

AJ-2485 Steinmann  
Tendon Holding Forceps  
16 cm / 6 1/4"

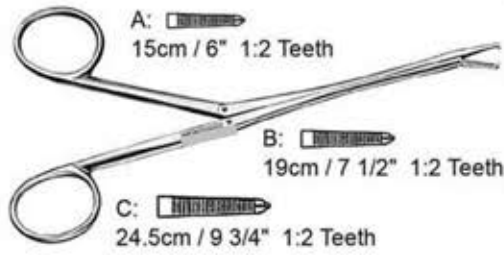

AJ-2486 A / B / C  
Brand Tendon Tunnelling Forceps

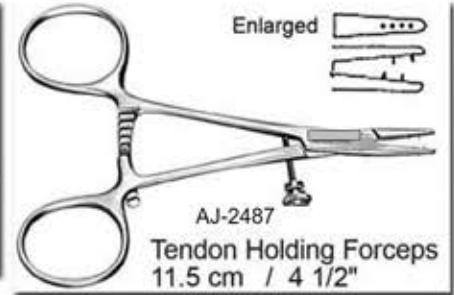

AJ-2487  
Tendon Holding Forceps  
11.5 cm / 4 1/2"

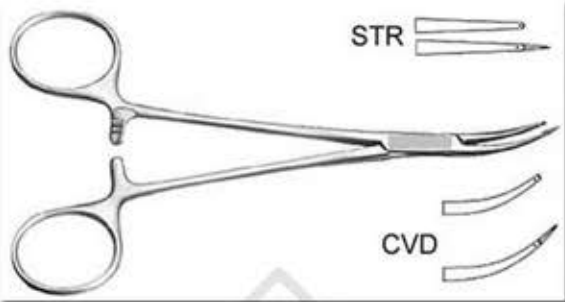

AJ-2488 Tendon Interlacing Forceps  
15.5 cm / 6" Pointed

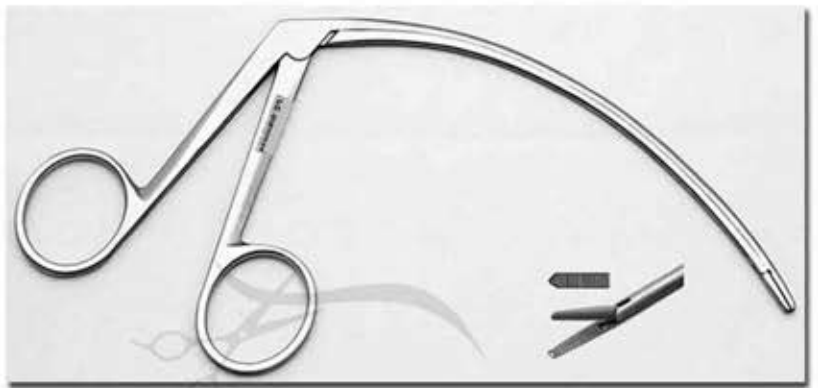

AJ-2489  
Carroll Tendon Holding Forceps 11.5 cm / 4 1/2"

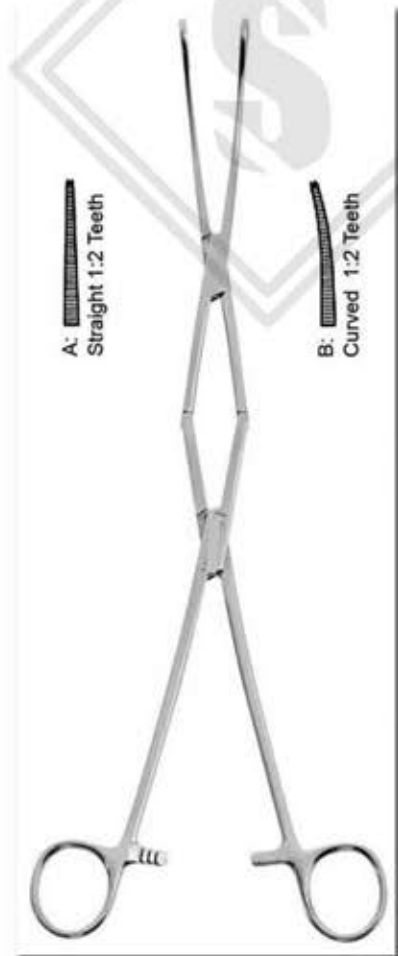

AJ-2490  
Hallman Tendon Tunnelling Forceps  
21 cm / 8 1/4"

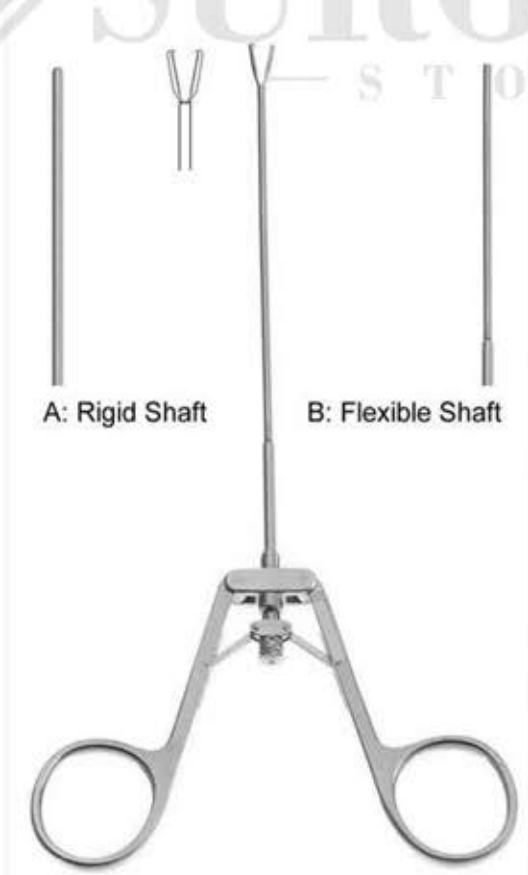

AJ-2491  
Kleinert-Kutz Tendon Holding Forceps  
21 cm / 8 1/4" 1X2 teeth



AJ-2492  
Hoen Grasping Forceps  
14 cm / 5 1/2" (Shaft)  
1X2 teeth

# BONE GRASPERS - MENISCUS CLAMPS



AJ-2493

Meniscus Clamp  
13.5 cm / 5 3/8" 1X2 teeth

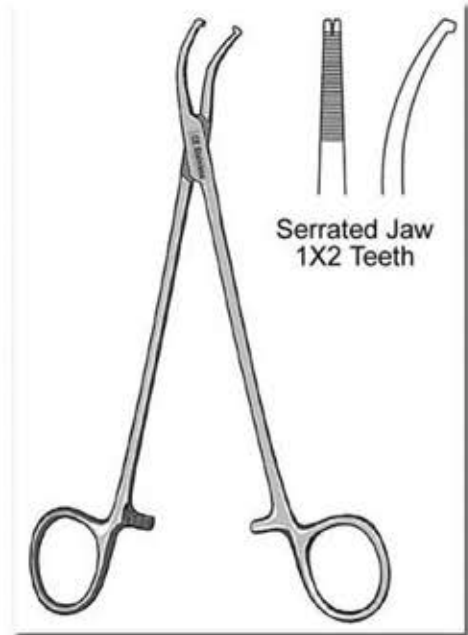

AJ-2494

Preston Ligamentum Flavum Forceps  
(Meniscus) 18.5 cm / 7 1/4"



Straight

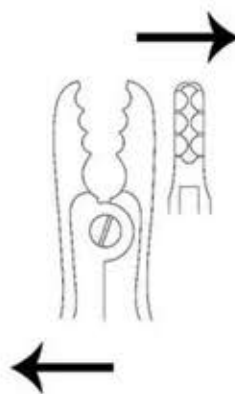

Angled

AJ-2494

Ortho Grasper 21 cm / 8 1/2"  
7 X 20 MM Bite



PELVIC REDUCTION INSTRUMENTS

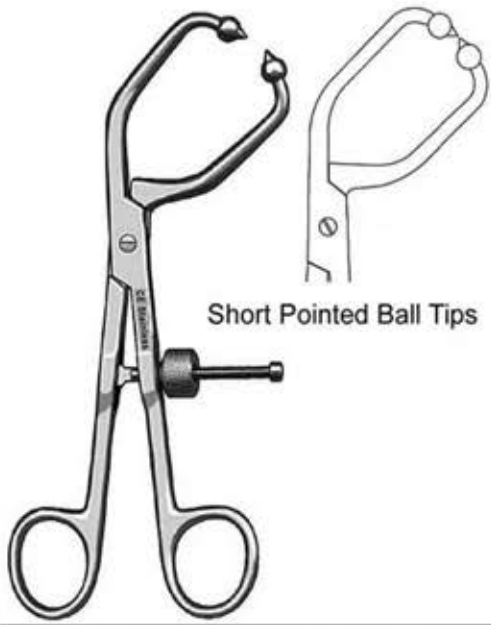

Short Pointed Ball Tips

AJ-2495 Pelvic Reduction Forceps  
19 cm / 7 3/8" Angular

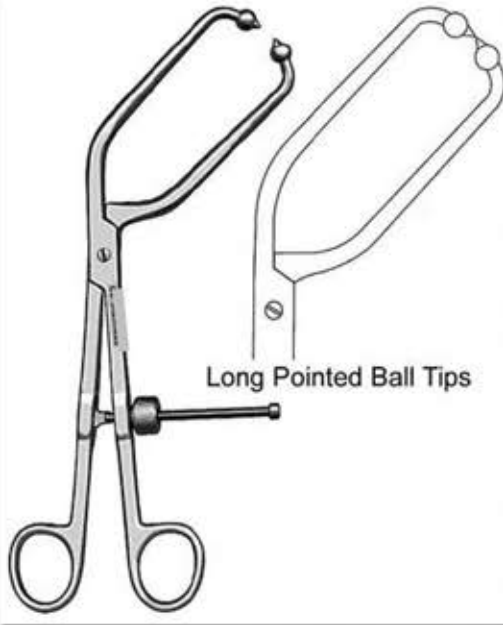

Long Pointed Ball Tips

AJ-2496 Pelvic Reduction Forceps  
24.5 cm / 9 5/8" Angular

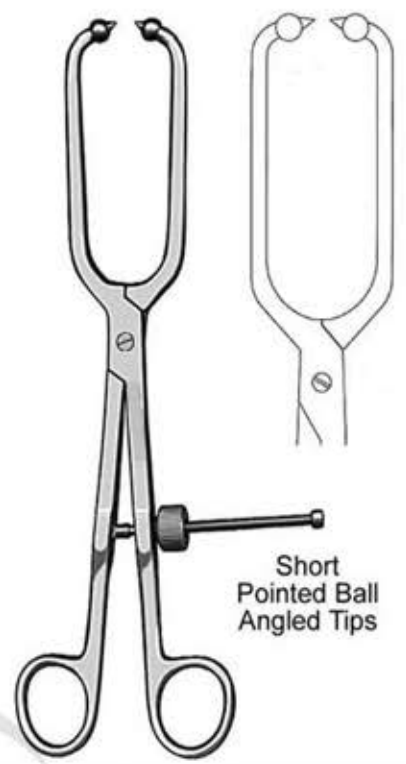

Short Pointed Ball Angled Tips

AJ-2497

Pelvic Reduction Forceps  
25 cm / 10"



AJ-2498

Pelvic Reduction Forceps

Available in 2 Sizes  
A: 24 cm / 9 1/2"  
B: 41 cm / 16"

Long Pointed Ball Tips

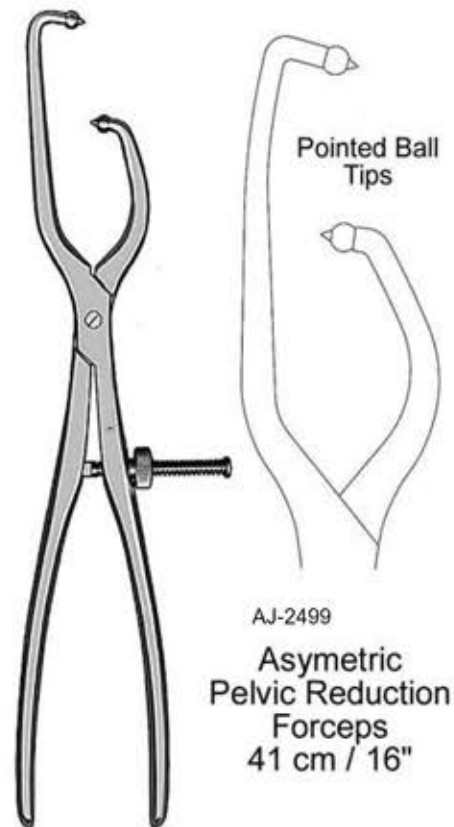

Pointed Ball Tips

AJ-2499

Asymmetric Pelvic Reduction Forceps  
41 cm / 16"

# PELVIC REDUCTION INSTRUMENTS



Pelvic Reduction Forceps  
Long 1X2  
Pointed Ball Tips  
41 cm / 16"

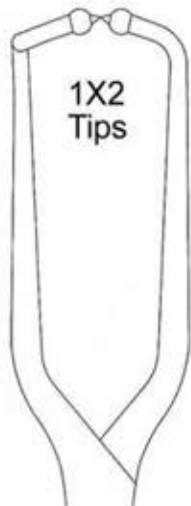

1X2  
Tips

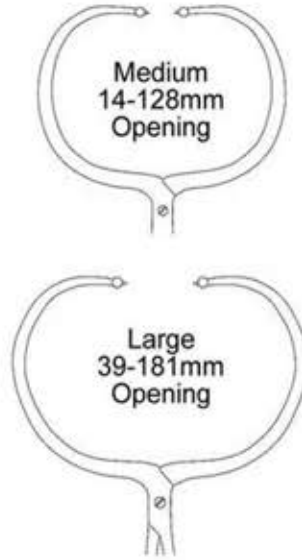

Medium  
14-128mm  
Opening

Large  
39-181mm  
Opening

Periarticular  
Reduction Forceps  
Straight  
Pointed Ball Tips  
38 cm / 15"



Pelvic  
Reduction Forceps  
Adjustable Jaws for Screws  
A: 25 cm / 10"  
B: 33 cm / 13"



# BONE HOLDING FORCEPS

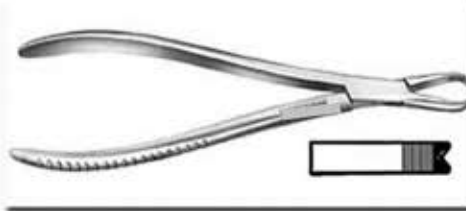
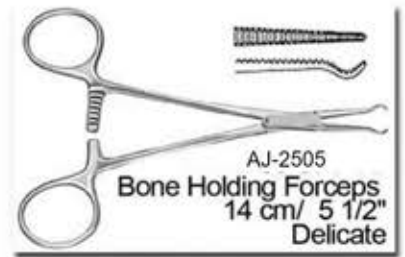

AJ-2506 Frosch Bone Holding Forceps 18 cm / 7"

AJ-2507 Bone Holding Forceps 20 cm / 8"

AJ-2508 Semb Bone Holding Forceps 19 cm / 7 1/2"

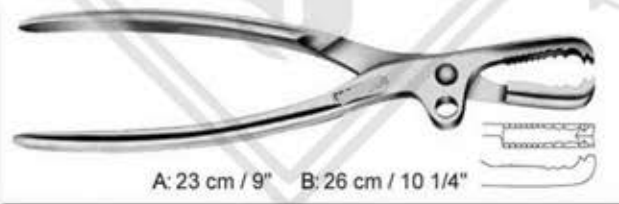
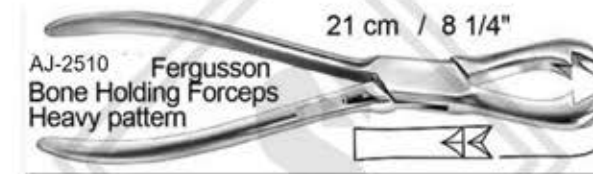

AJ-2511  
Farabeuf Bone Holding Forceps

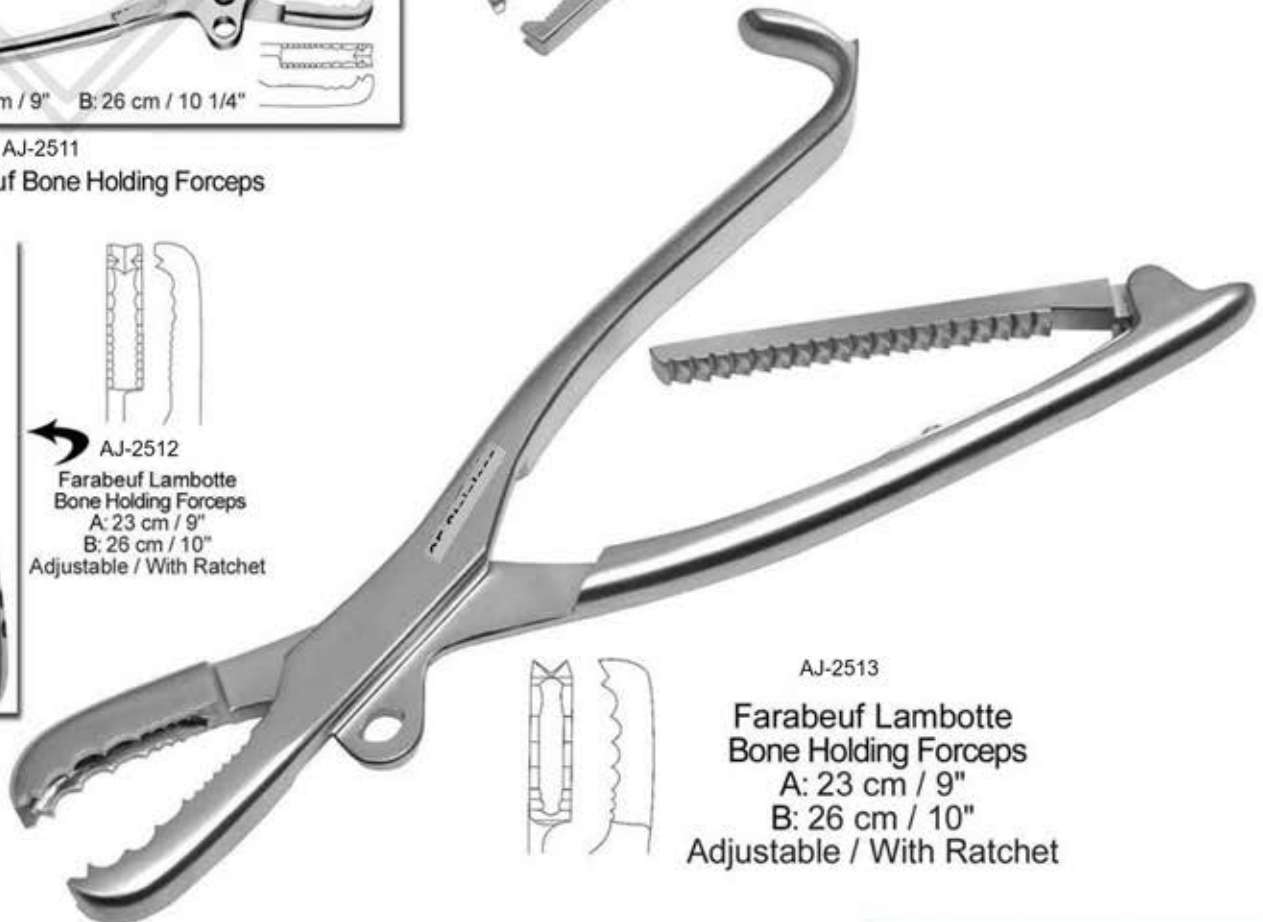
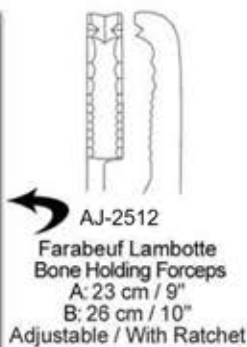

# BONE HOLDING FORCEPS

AJ-2514

Lambotte Bone Holding Forceps  
w/ Swivel Head, Adjustable Jaw  
A: 22 cm / 8 3/4"  
A: 27 cm / 10 3/4"  
A: 30 cm / 11 3/4"

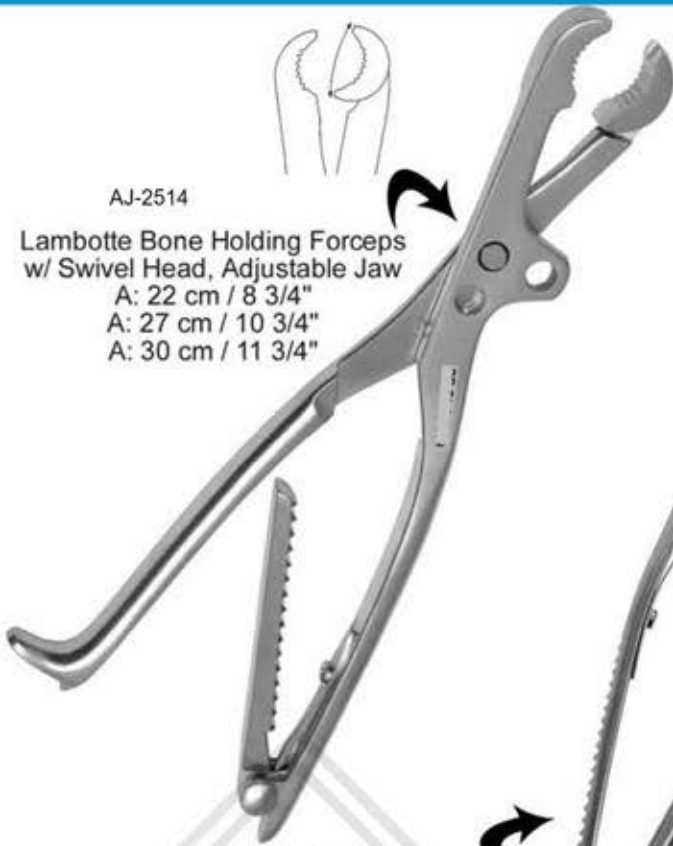

AJ-2515

Ulrich Bone Holding Forceps  
w/ Thread Fixation  
19 cm / 7 1/4"



Straight

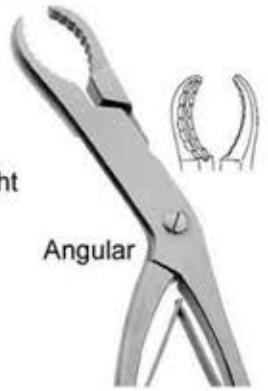

Angular

AJ-2516

Ulrich Bone Holding Forceps  
w/ Thread Fixation  
A: 23 cm / 9"  
A: 25 cm / 9 3/4"  
A: 28 cm / 11"



AJ-2517

Self Centering Bone Holding Forceps  
W/ Thread Fixation

Available in:  
Available in:  
A: 15 cm / 6"  
B: 19 cm / 17 1/2"  
C: 24 cm / 9 1/2"  
D: 26 cm / 10 1/4"  
E: 28 cm / 11"

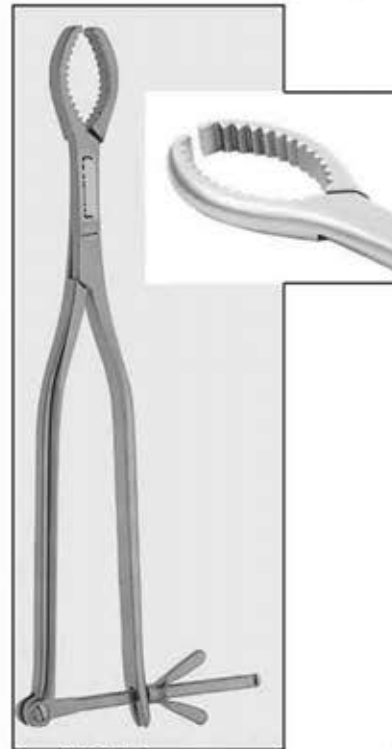

AJ-2518

Hey Groves Bone Holding Forceps  
A: 20 cm / 8"  
B: 25 cm / 10"  
C: 30 cm / 12"



AJ-2519  
without Ratchet

AJ-2520

Lane Bone Holding Forceps  
w/ Ratchet  
A: 33 cm / 13"  
B: 45 cm / 17 3/4"



# BONE HOLDING FORCEPS

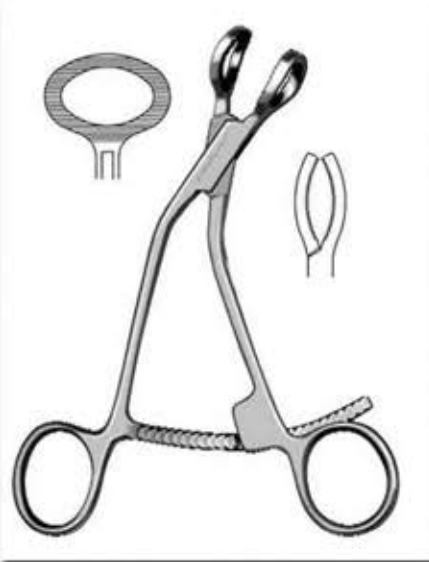
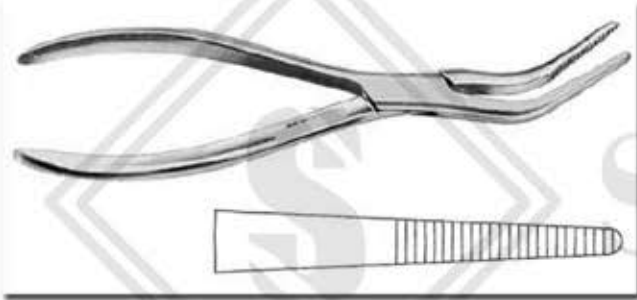

# CARTILAGE - REPOSITION FORCEPS



AJ-2528  
Walton  
Cartilage Seizing Forceps  
20.5 cm / 8"  
A: Straight  
B: Upward Cvd  
C: Sideward Cvd

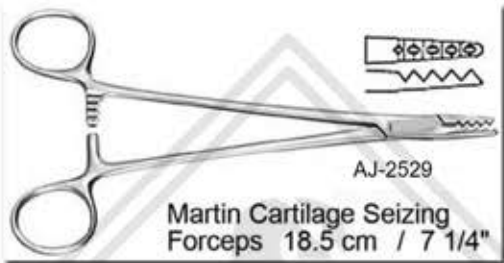

AJ-2529  
Martin Cartilage Seizing  
Forceps 18.5 cm / 7 1/4"



AJ-2530  
Dingmann Cartilage Seizing  
Forceps 18.5 cm / 7 1/4"

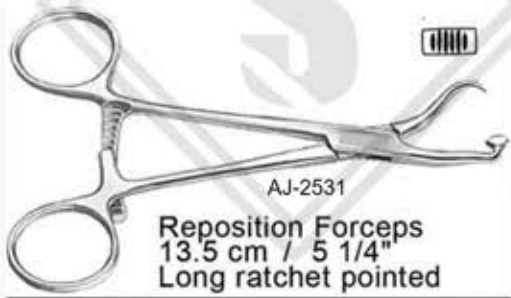

AJ-2531  
Reposition Forceps  
13.5 cm / 5 1/4"  
Long ratchet pointed



AJ-2532  
Reposition Forceps  
15 cm / 6"  
Long Ratchet Pointed



AJ-2533  
Walton Bone  
Reduction Forceps  
20.5 cm / 8"  
2" Double Ratchet  
Opening 9-100mm

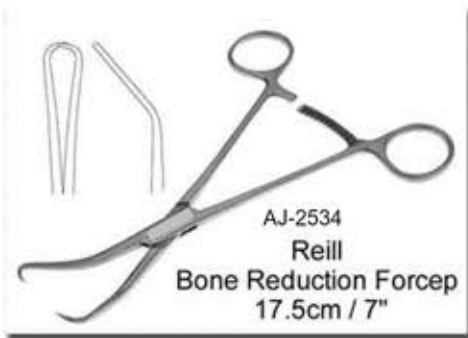

AJ-2534  
Reill  
Bone Reduction Forcep  
17.5cm / 7"

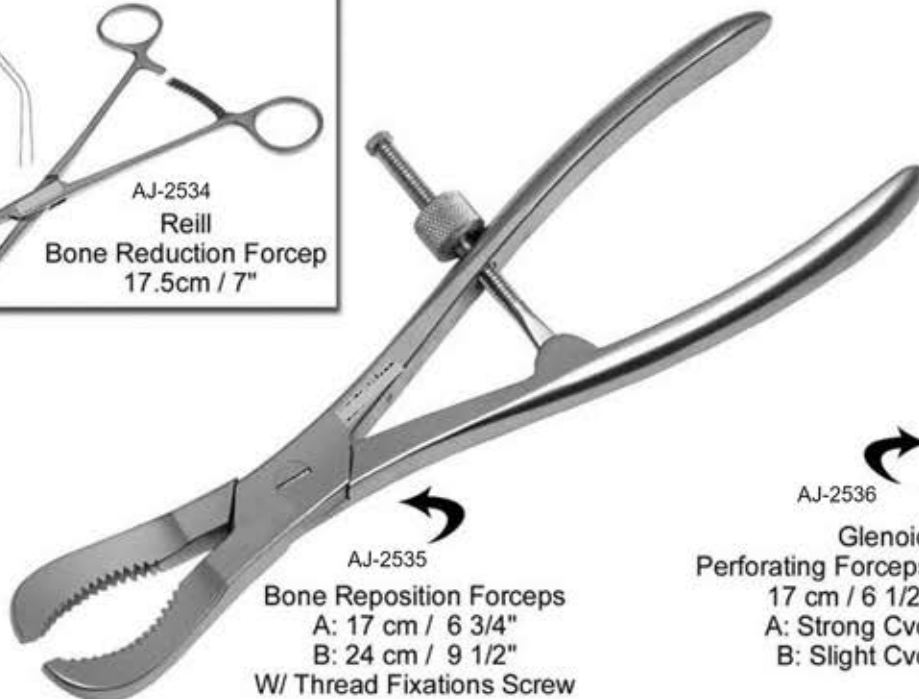

AJ-2535  
Bone Reposition Forceps  
A: 17 cm / 6 3/4"  
B: 24 cm / 9 1/2"  
W/ Thread Fixations Screw

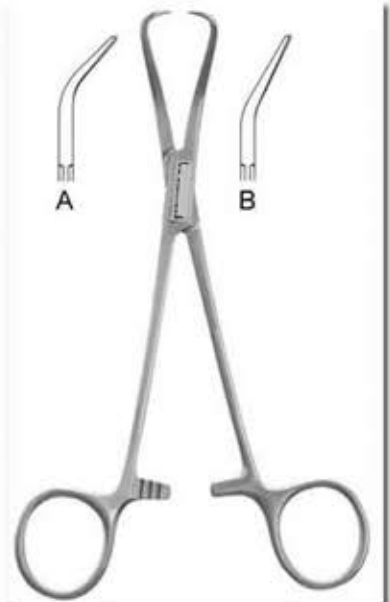

AJ-2536  
Glenoid  
Perforating Forceps  
17 cm / 6 1/2"  
A: Strong Cvd  
B: Slight Cvd

# BONE CUTTING FORCEPS

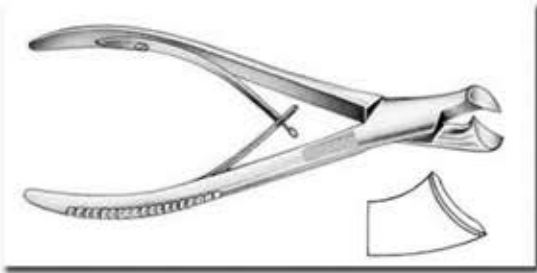

AJ-2537  
Marwalder Bone Nipper 18.5 cm / 7 1/4"

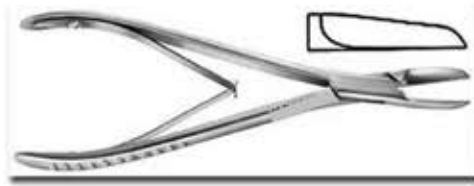

AJ-2537  
Cottle Kazanjian Bone Cutting Forceps  
18.5 cm / 7 1/4"

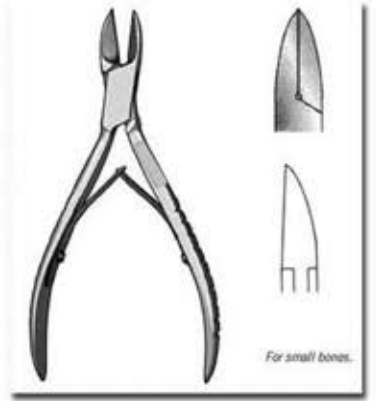

AJ-2538  
Littauer Bone Cutting Forceps  
15 cm / 6"



AJ-2539  
Liston Bone Cutting Forceps



AJ-2540  
Cleveland Bone Cutting Forceps  
A: 14.5 cm / 5 3/4"  
B: 17 cm / 6 3/4"

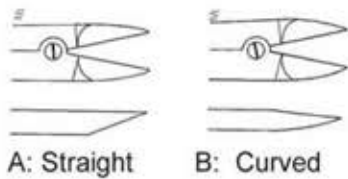
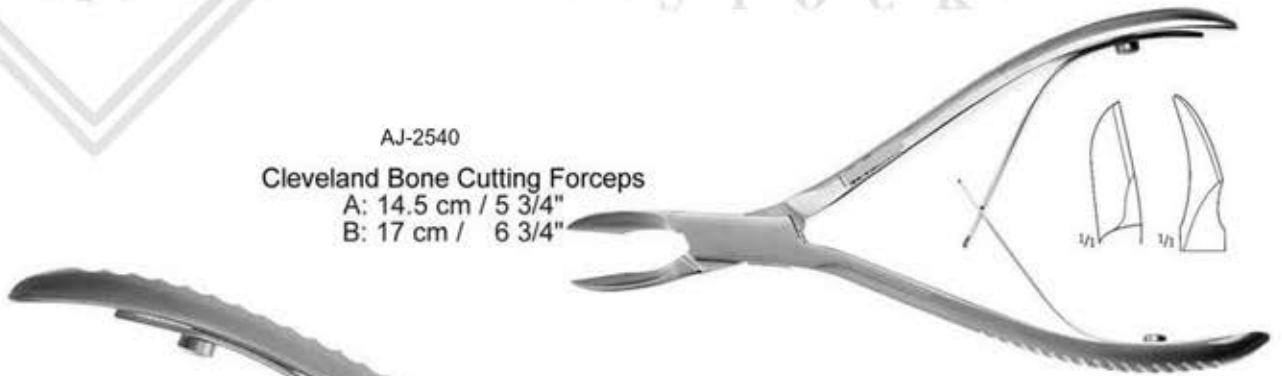

AJ-2541  
Kleinert-Kutz / Böhler Bone Cutting  
Forceps 14.5 cm / 5 3/4"

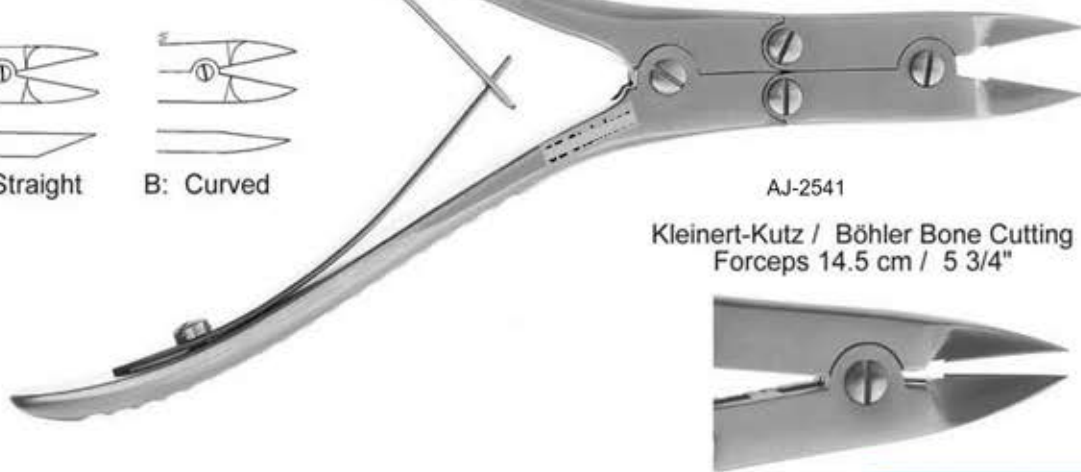



# BONE CUTTING FORCEPS



AJ-2542  
Mc Indoe  
Bone Cutting Forceps  
18 cm / 7"  
Delicate Blades



AJ-2543  
Stille-Horsley / Liston Key  
Bone Cutting Forceps  
25.5 cm / 10"

45° Angled



90° Angled

Angled On Side

AJ-2544  
Semb  
Bone Cutting Forceps  
24.5 cm / 9 3/4"

# BONE RONGEURS - NIBBLERS

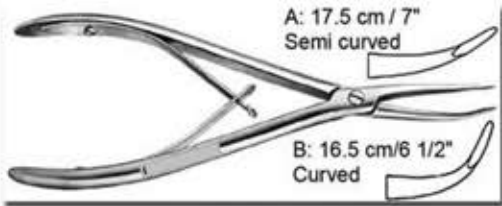

AJ-2545 Stellbrink Bone Rongeur

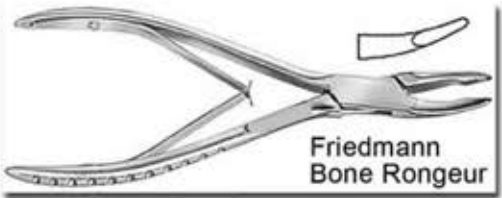

AJ-2547 Friedmann Bone Rongeur



Friedmann Bone Rongeur



AJ-2552 Cleveland Bone Rongeur



AJ-2553 Mead Bone Rongeur

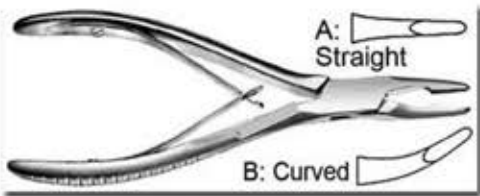

AJ-2555 Jansen Bone Rongeur 18 cm / 7"



AJ-2556 Lempert Bone Rongeur

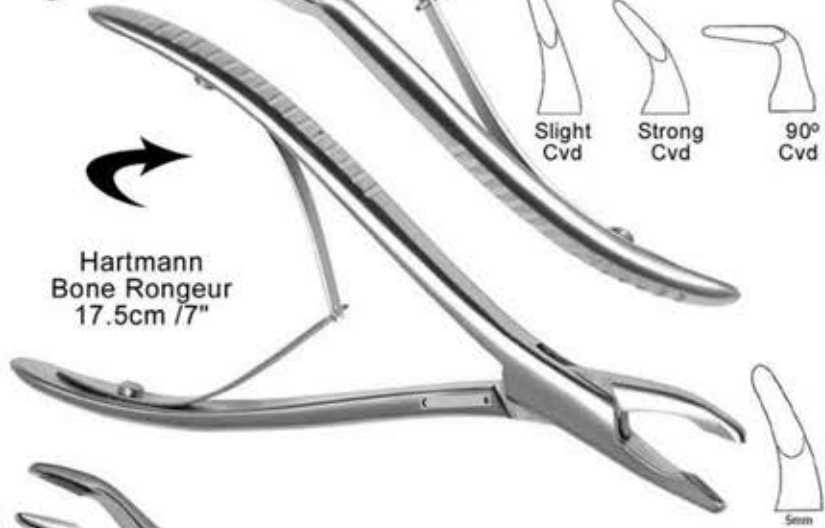

Hartmann Bone Rongeur



AJ-2550 Jansen Bone Rongeur

AJ-2551 Jansen Bone Rongeur A: 14 cm / 5 1/2" B: 17 cm / 6 1/2" Straight



AJ-2554 Jansen Bone Rongeur



AJ-2557 Luer Bone Rongeur



AJ-2558 Luer Bone Rongeur 18.5 cm / 7 1/4"

# BONE RONGEURS - NIBBLERS



AJ-2559 Böhler Bone Rongeur  
15.5 cm / 6"



AJ-2561 Beyer Bone Rongeur  
18 cm / 7"



AJ-2562 Zaufal-Jansen  
Bone Rongeur 18 cm / 7"



AJ-2563  
Mayfield Bone Rongeur  
18 cm / 7"



AJ-2565 Marquard  
Bone Rongeur 20.5 cm / 8"



AJ-2560  
Stille Bone Rongeur  
22.5 cm / 8 3/4"

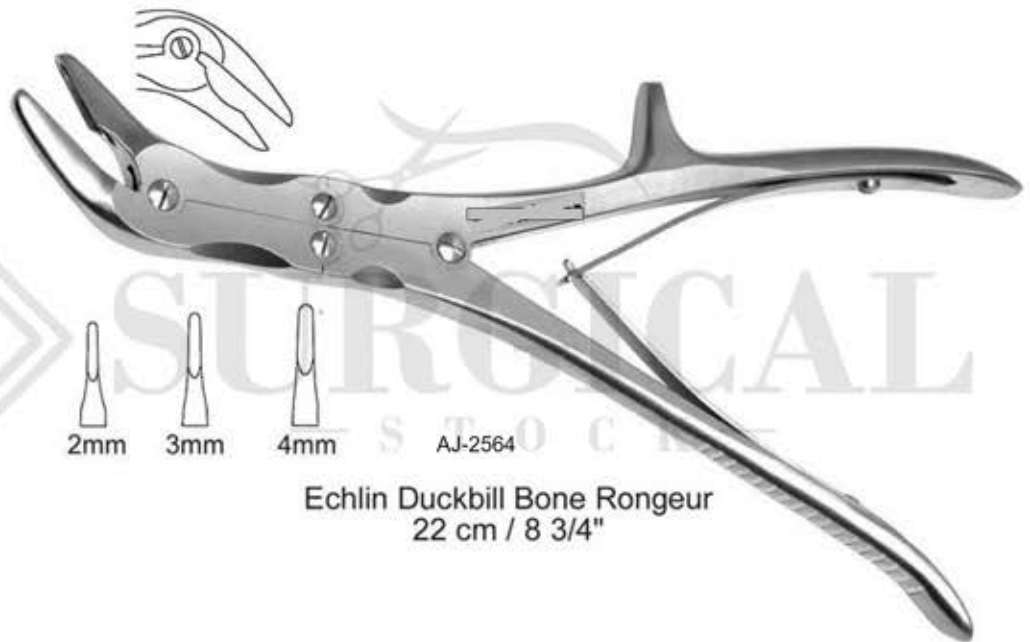

AJ-2564  
Echlin Duckbill Bone Rongeur  
22 cm / 8 3/4"

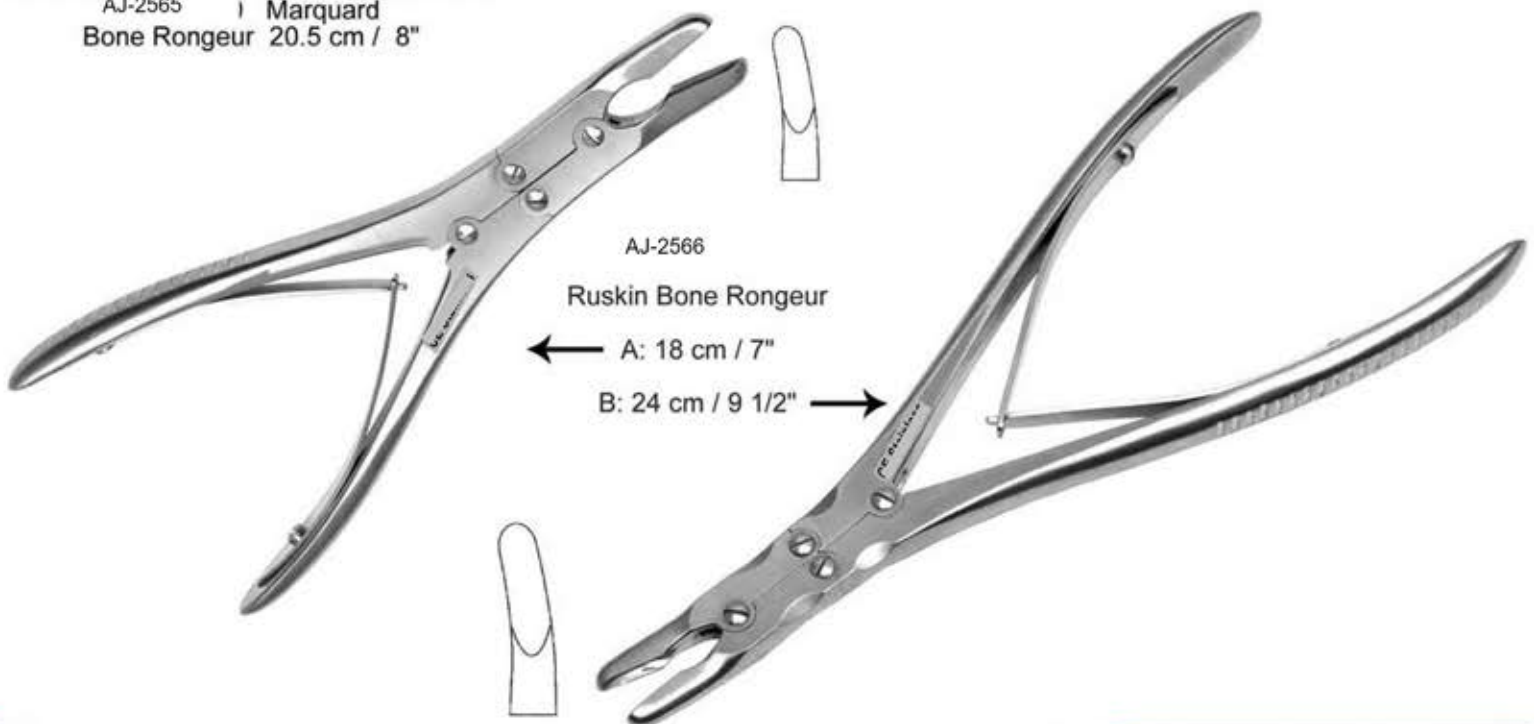

AJ-2566  
Ruskin Bone Rongeur  
← A: 18 cm / 7"  
B: 24 cm / 9 1/2" →



# BONE RONGEURS - NIBBLERS



AJ-2567  
Leksell Stille  
Bone Rongeur  
24 cm / 9 1/2"

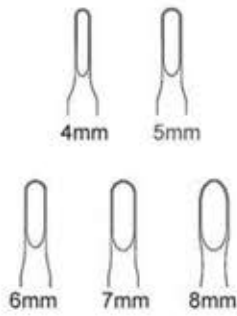

Same Size In  
Both Rongeurs



AJ-2568  
Leksell  
Bone Rongeur  
24 cm / 9 1/2"

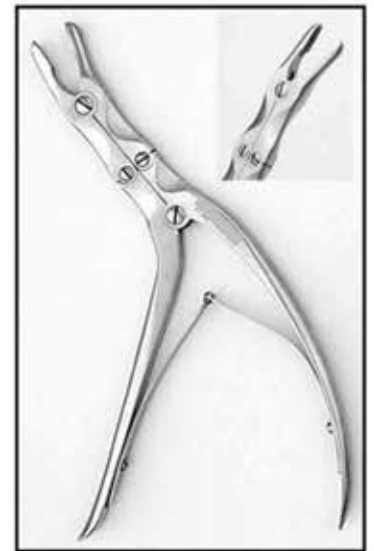

AJ-2569  
Leksell Bone Rongeur  
24 cm / 9 1/2"  
4 / 5 / 6 / 7 / 8mm

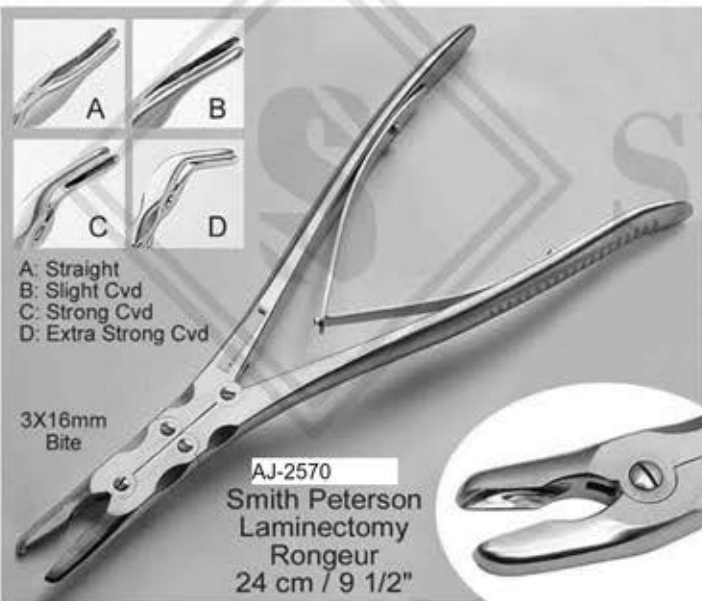

AJ-2570  
Smith Peterson  
Laminectomy  
Rongeur  
24 cm / 9 1/2"

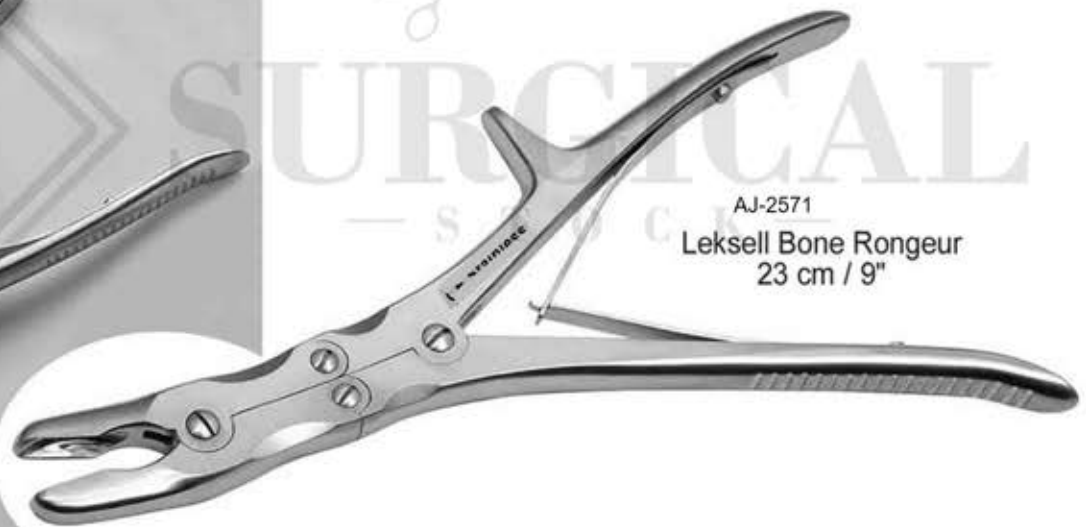

AJ-2571  
Leksell Bone Rongeur  
23 cm / 9"

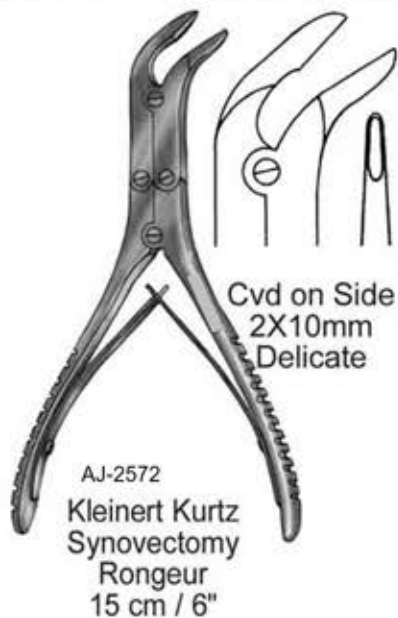

AJ-2572  
Kleinert Kurtz  
Synovectomy  
Rongeur  
15 cm / 6"

Cvd on Side  
2X10mm  
Delicate

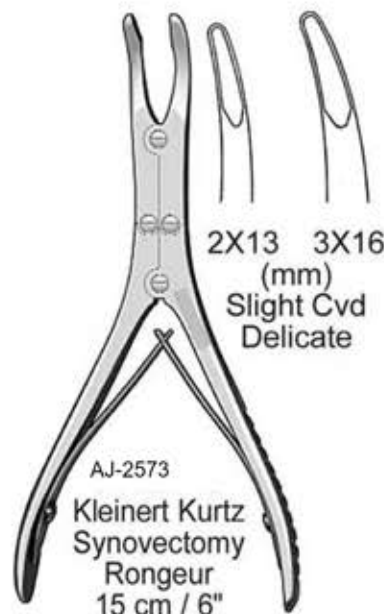

AJ-2573  
Kleinert Kurtz  
Synovectomy  
Rongeur  
15 cm / 6"

2X13 3X16  
(mm)  
Slight Cvd  
Delicate

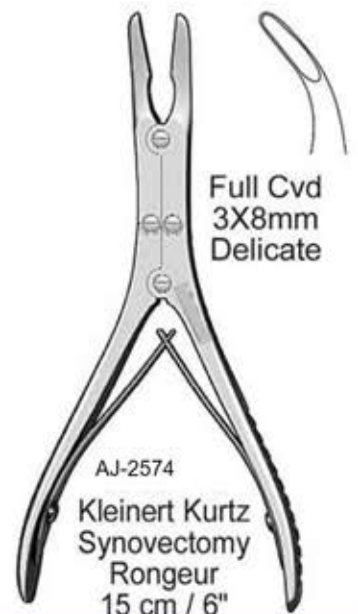

AJ-2574  
Kleinert Kurtz  
Synovectomy  
Rongeur  
15 cm / 6"

Full Cvd  
3X8mm  
Delicate

# BONE RONGEURS - NIBBLERS

Tooth  
Inside



Semb Bone Rongeur  
23.5 cm / 9 1/4"

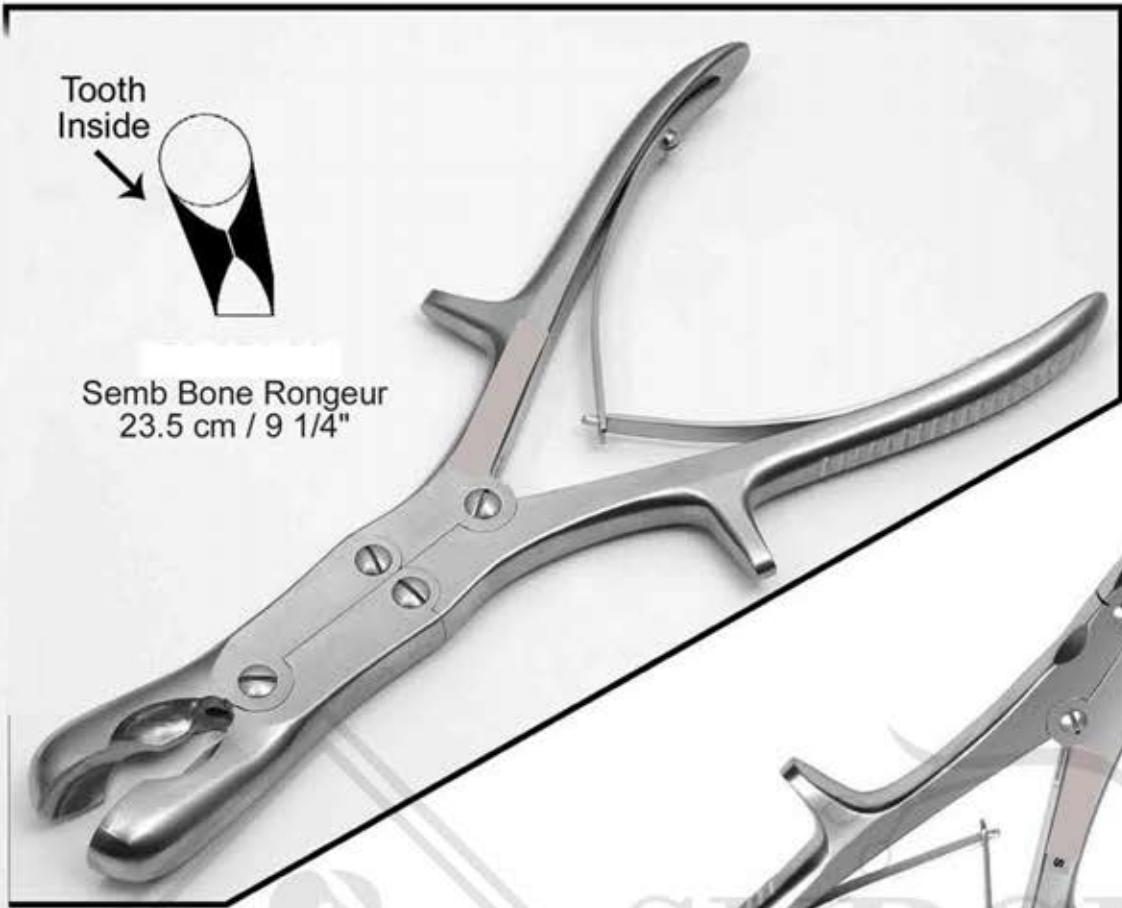

8mm

Stille Ruskin  
Bone Rongeur  
23.5 cm / 9 1/4"

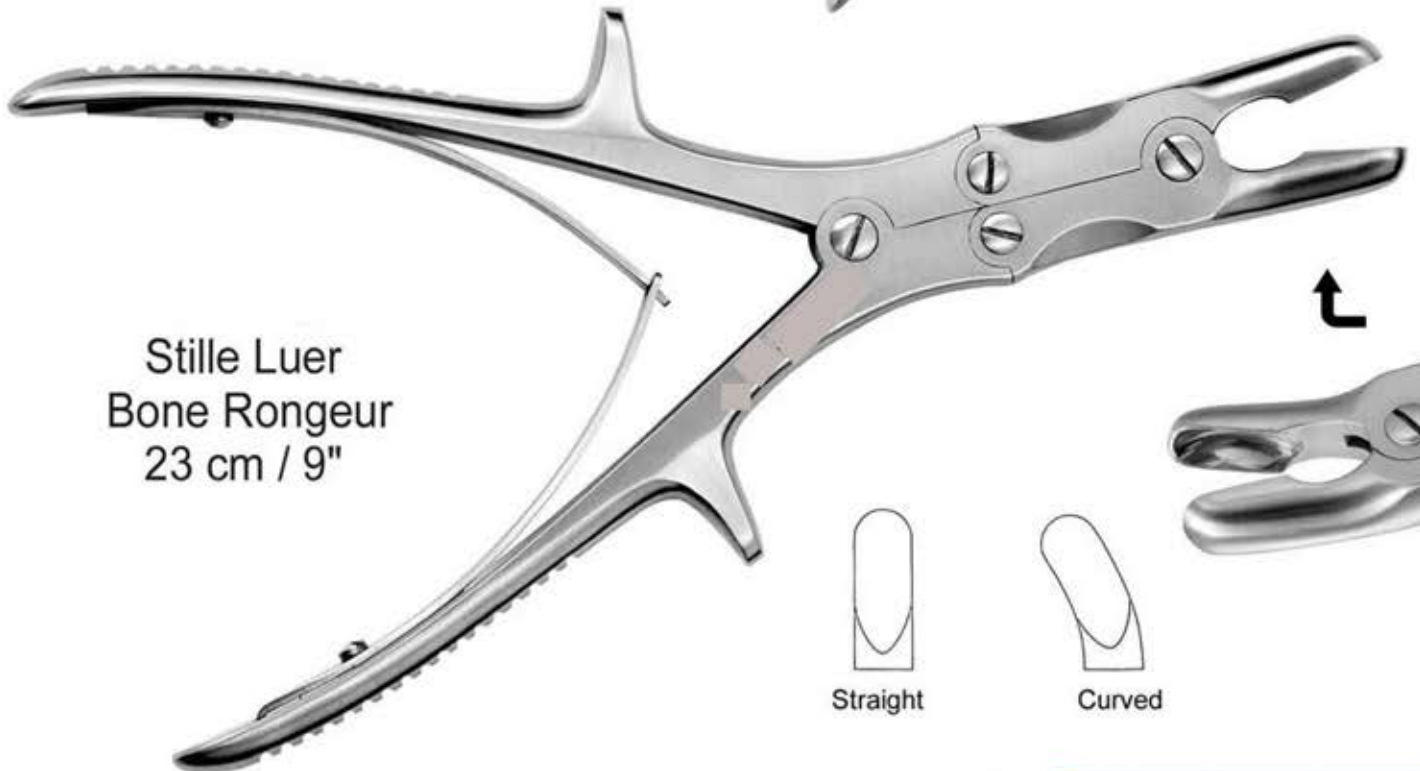

Stille Luer  
Bone Rongeur  
23 cm / 9"



Straight



Curved



# BONE RONGEURS - NIBBLERS

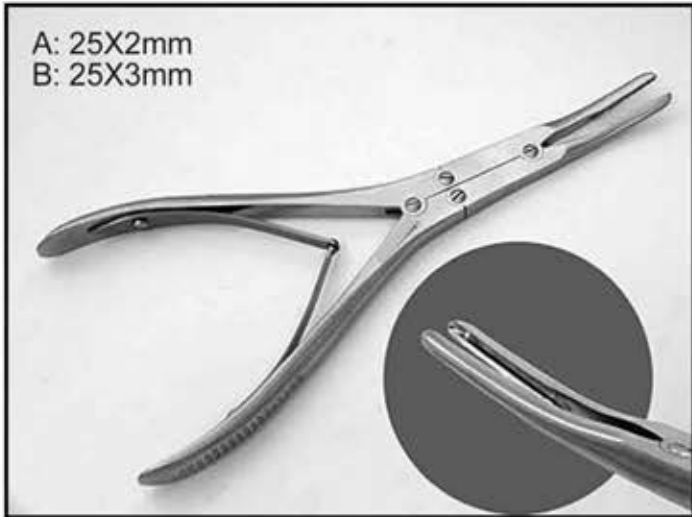

A: 25X2mm  
B: 25X3mm

AJ-2578

Mainz Long Neck Bone Rongeur 18 cm / 7"

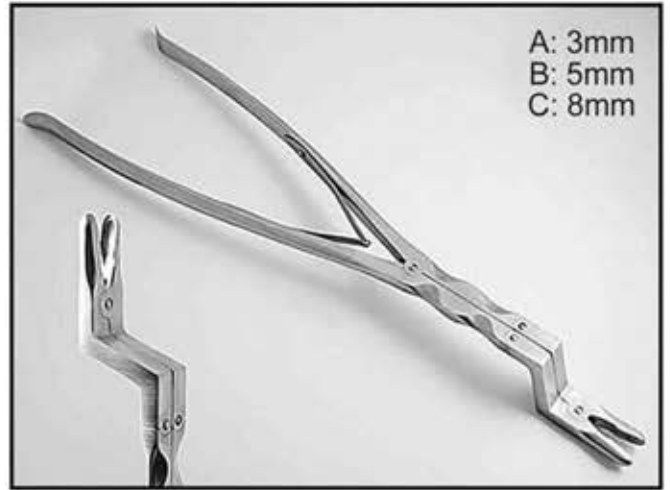

A: 3mm  
B: 5mm  
C: 8mm

AJ-2579

Leksell Bayonet Rongeur 41 cm / 16"

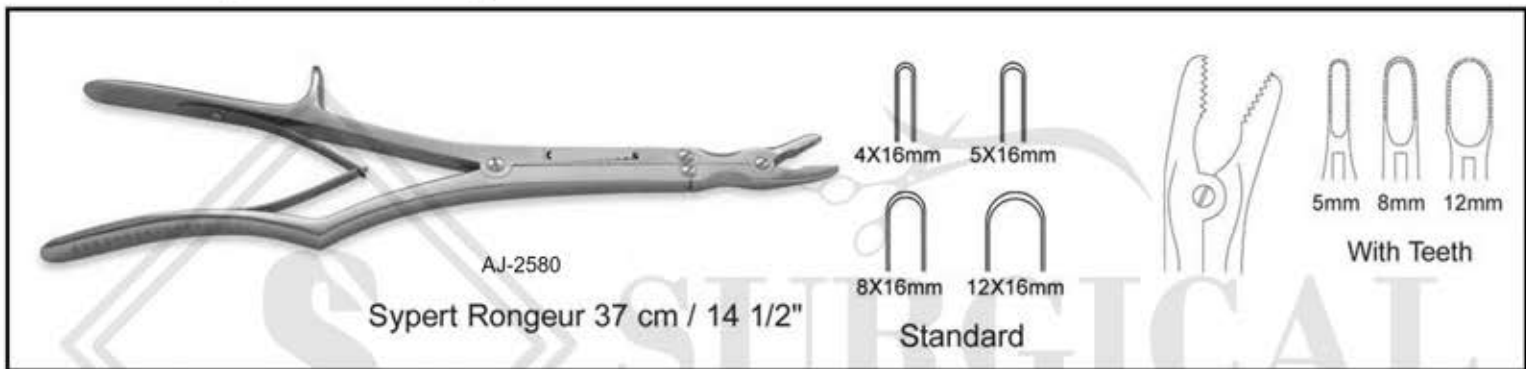

AJ-2580

Sypert Rongeur 37 cm / 14 1/2"

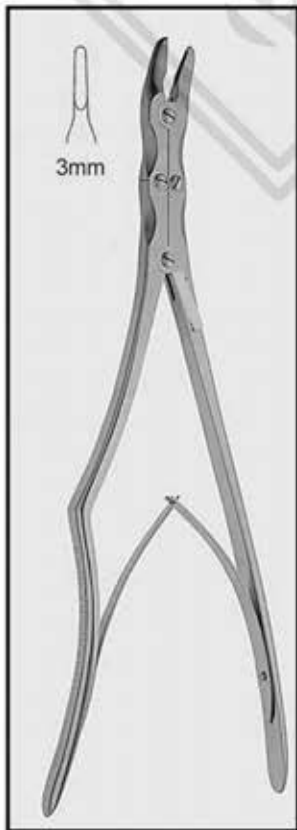
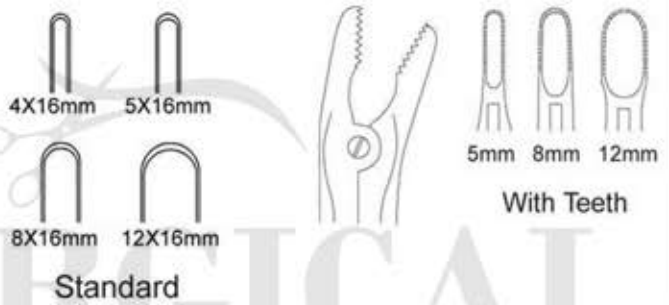

3mm

AJ-2581

Dale Thoracic Rongeur 37 cm / 14 1/2"

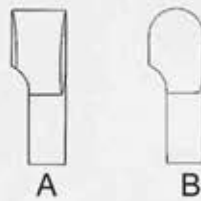
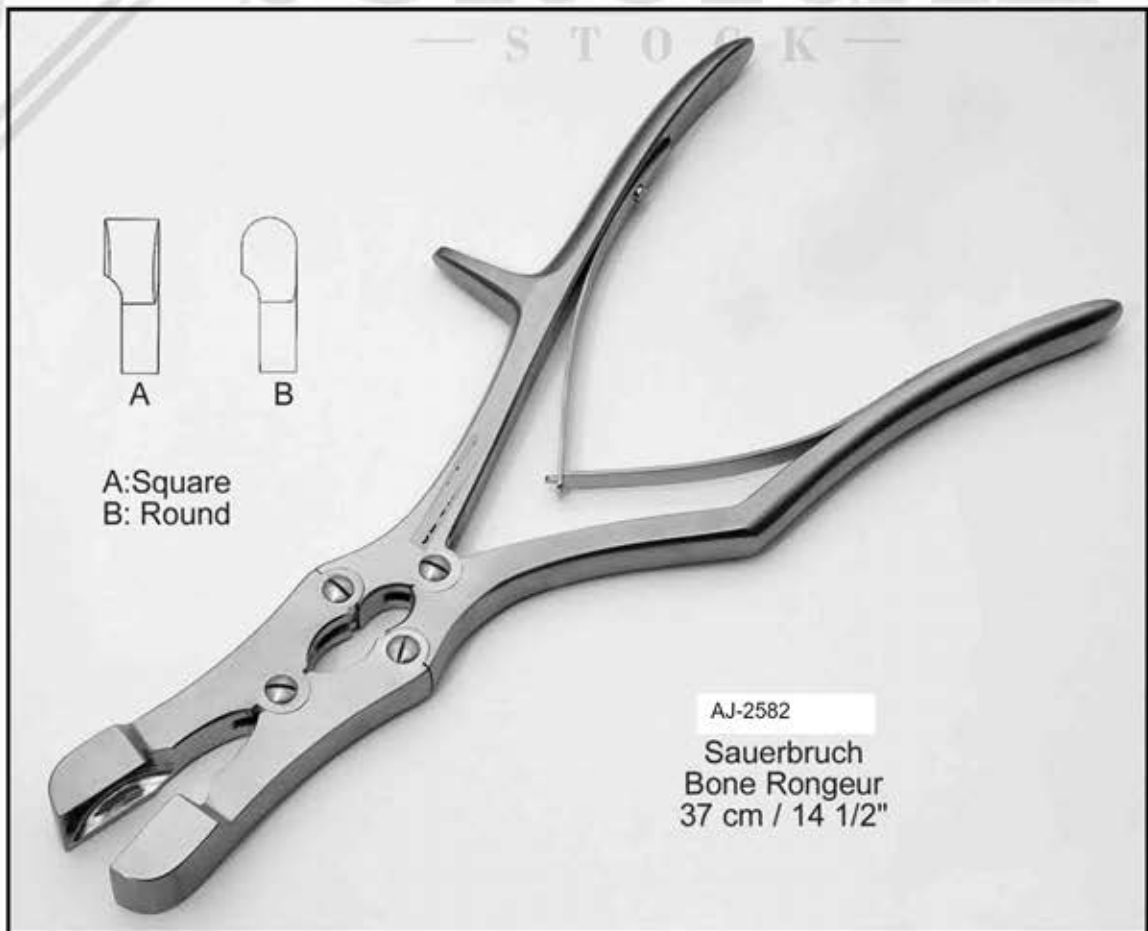

A: Square  
B: Round

AJ-2582

Sauerbruch Bone Rongeur 37 cm / 14 1/2"



# RIB SHEARS



AJ-2583  
Rib Shear  
Double Spring  
22 cm / 8 3/4"



AJ-2584  
Rib Shear  
Double Spring  
A: 20 cm / 8"  
B: 23 cm / 9"



AJ-2585  
Collin Rib Shear  
17.5 cm / 7"



AJ-2586  
Collin Rib Shear  
17 cm / 6 3/4"



AJ-2587  
Stille Rib Shear  
21 cm / 8 1/4"



AJ-2588  
Gluck  
Rib Shear  
A: 16 cm / 6"  
B: 18 cm / 7"  
C: 20 cm / 8"  
D: 23 cm / 9"

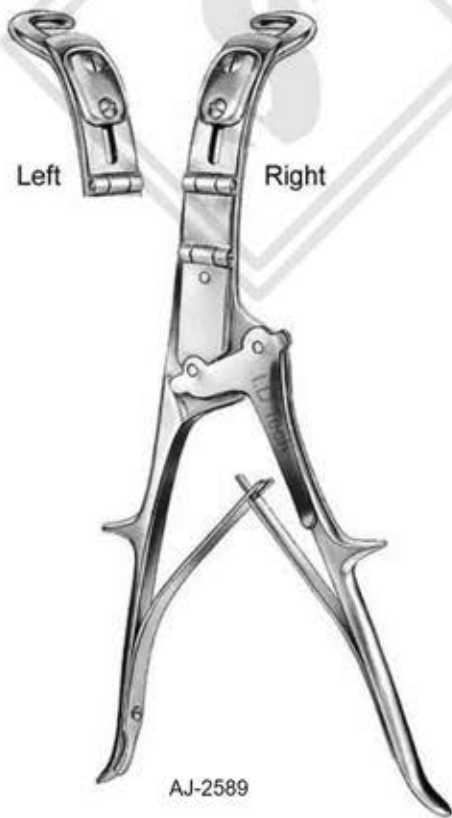

AJ-2589  
Brunner  
Rib Shear  
28 cm / 11"



AJ-2590  
Giertz Stille  
Rib Shear  
25 cm / 10"



AJ-2591  
Sauerbruch  
Rib Shear  
A: 23 cm / 9"  
A: 26 cm / 10 1/4"

SURGICAL  
— STOCK

# RIB SHEARS - STERNUM CHISEL



AJ-2592  
Labsche  
Rib Shear  
25 cm / 10"



AJ-2593  
T Handle Labsche Sternum Chisel  
24 cm / 9 1/2"



AJ-2594  
Rib Shear  
Sideward  
17 cm / 6 3/4"



Pointed  
Tips  
AJ-2595 A  
Bethune Rib Shear  
S Shaped Handle  
34 cm / 13 1/2"



AJ-2596  
Bethune Rib Shear  
S Shaped Handle  
34 cm / 13 1/2"



AJ-2597  
Coryllos-Bethune Rib Shear  
S Shaped Handle  
35 cm / 13 3/2"



Left Right



AJ-2598  
Roos Rib Shear  
Right Angled Jaw W/ Hook  
33 cm / 13"

# SPREADERS

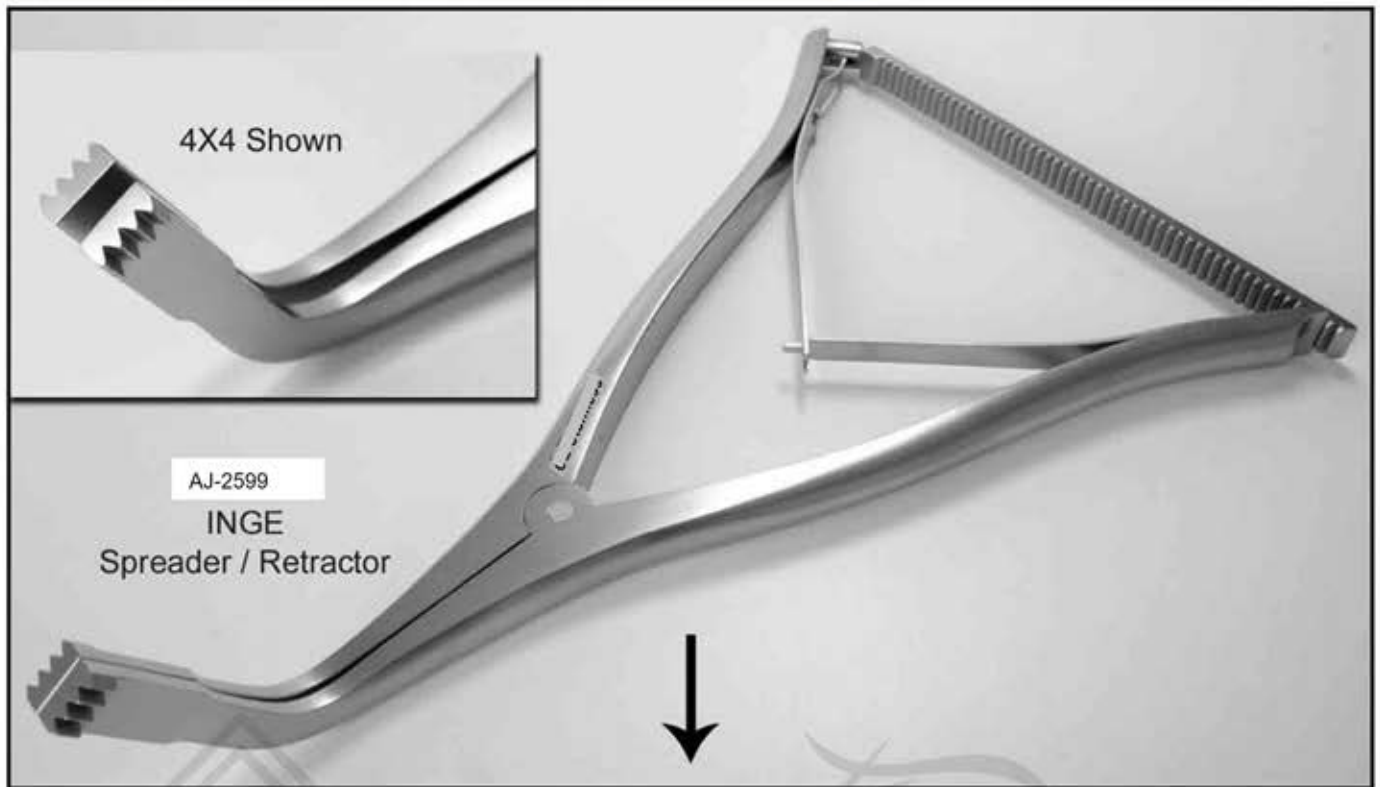

AJ-2599

**INGE**  
Spreader / Retractor

4X4 Shown

Available in 4X4 and 6X6 Teeth  
and Without Teeth (Plain)

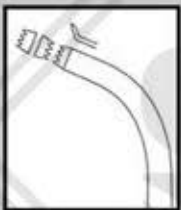

A: 4X4 Teeth  
B: Without Teeth  
16.5 cm / 6 1/2"



C: 4X4 Teeth  
D: Without Teeth  
25.5 cm / 10"

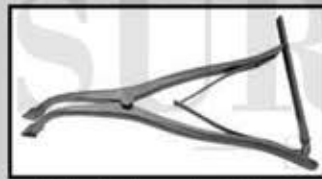

10 Inch Length Pattern

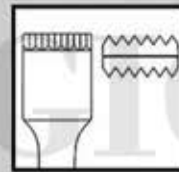

A: 6X6 Teeth  
B: Without Teeth  
27 cm / 10 1/2"  
Flat Blades



C: 6X6 Teeth  
C: Without Teeth  
27 cm / 10 1/2"  
Concave Blades

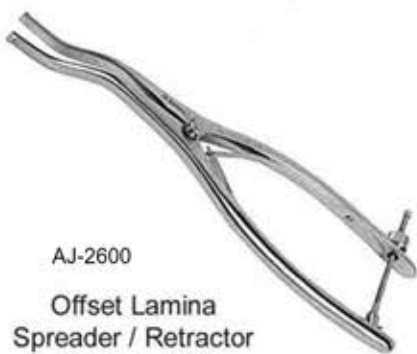

AJ-2600

Offset Lamina  
Spreader / Retractor  
25.5 cm / 10"

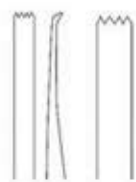

AJ-2601

Vertebra  
Spreader  
/ Retractor  
A: 18 cm / 7"  
B: 28 cm / 11"



AJ-2602

Inge Spreader  
Serrated Outside  
Blades  
A: 18 cm / 7"



AJ-2603  
Saxsena Lamina  
Spreader / Retractor  
A: 18 cm / 7"  
B: 25.5 cm / 10"  
Serrated Outside  
Blades





## SPREADERS



AJ-2604  
Calcaneal Spreader  
Smooth Pads 15X12mm  
18 cm / 7"



AJ-2605  
Calcaneal Spreader  
Grooved Pads 15X12mm  
18 cm / 7"



AJ-2606  
Lombardi Femoral  
Tibial Spreader (Small)  
A: Grooved Pads 22X13mm  
18 cm / 7"



B: Damond Cut Pads 22X13mm



B: Damond Cut Pads 22X13mm



AJ-2607  
Lombardi Femoral  
Tibial Spreader (Large)  
A: Grooved Pads 22X13mm  
23.5 cm / 9 1/4"

## COMPRESSION - DISTRACTING FORCEPS



AJ-2608  
Compressing Forceps  
28 cm / 11"  
Adjustable Locking  
For Screws and Rods



AJ-2609  
Distracting Forceps  
23 cm / 9"  
Long Ratchet / Spiral Spring  
For Screws and Rods



AJ-2610  
Distracting Forceps  
25.5 cm / 10"  
Leaf Spring  
For Screws and Rods



AJ-2611  
Compression Forceps  
28 cm / 11"  
Leaf Spring / Long Ratchet  
For Screws and Rods



AJ-2611  
Distractor  
25.5 cm / 10"  
Leaf Spring  
For Screws and Rods

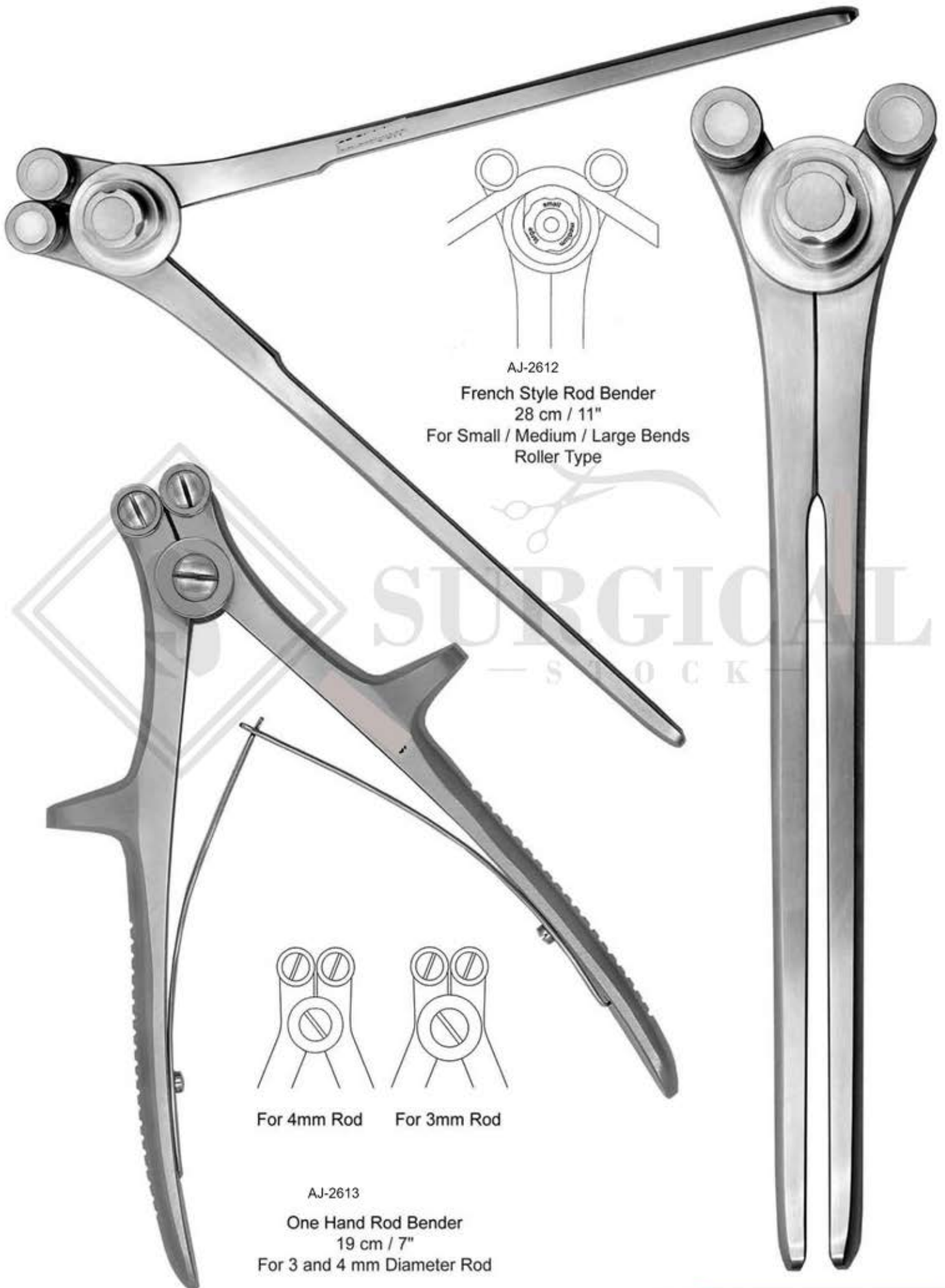



# CARBIDE INSERTED WIRE TWISTERS

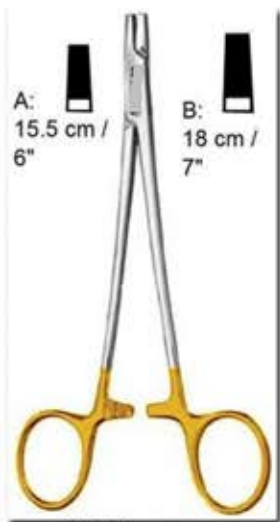

A: 15.5 cm / 6"  
B: 18 cm / 7"

AJ-2614  
Wire Twisting  
Forceps

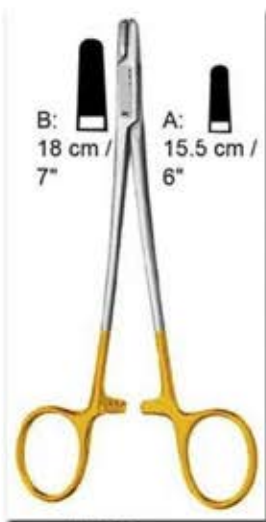

B: 18 cm / 7"  
A: 15.5 cm / 6"

AJ-2615  
Wire Twisting  
Forceps

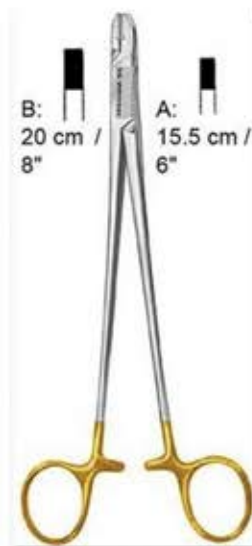

B: 20 cm / 8"  
A: 15.5 cm / 6"

AJ-2616  
Wire Twisting  
Forceps



AJ-2617 Corwin  
Combi-Wire Twisting  
Forceps  
18.5 cm / 7 1/4"



AJ-2618  
Wire Twisting Forceps  
15.5 cm / 6"



AJ-2619  
Wire Twisting Forceps  
16 cm / 6 1/4"



AJ-2620 Wire Twisting  
Forceps Heavy Pattern  
19 cm / 7 1/2"

The Corwin-Hegar automatic Wire Twister is a special automatic twisting Instrument. In combination with a cerclage wire it can be used for fixation of fractures or temporal fixation. The Automatic Wire Twisters are available in different lengths and with various tungsten carbide inserts.



AJ-2621 Corwin-Hegar  
Auto Wire Twisting Forceps  
15 cm / 6"

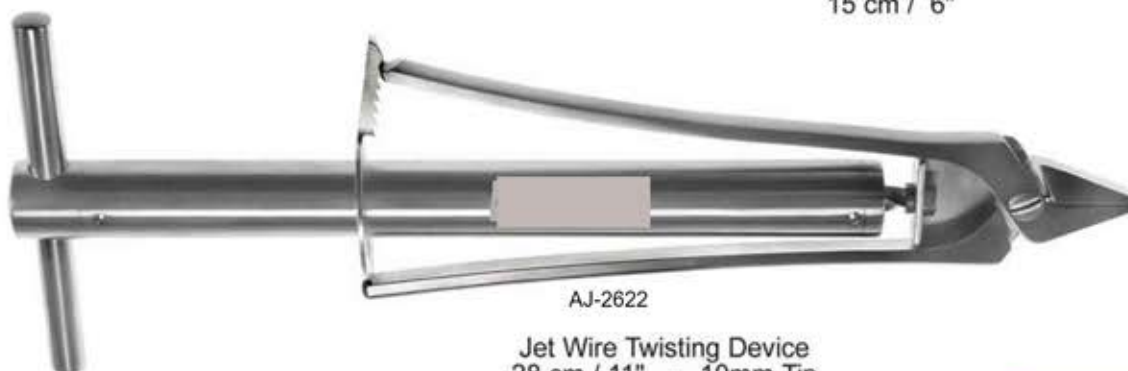

AJ-2622  
Jet Wire Twisting Device  
28 cm / 11" - 10mm Tip

# CARBIDE INSTERTED SURGICAL SCISSORS

Scissors in this Section can also be Manufactured without Carbide Tips / Gold Plating

AJ-2623

**Mayo Scissors TC Gold**  
 A: 14.5 cm / 5 3/4" Str or Cvd  
 B: 17 cm / 6 3/4" Str or Cvd  
 C: 23 cm / 9" Str or Cvd

Blunt / Blunt

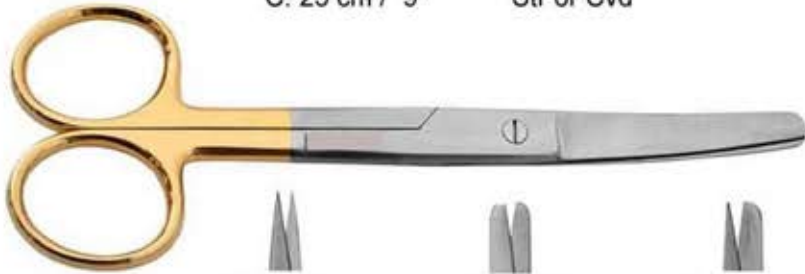

Sharp / Sharp  
Cvd or Str

Blunt / Blunt  
Cvd or Str

Sharp / Blunt  
Cvd or Str

Please Mention Above Styles When Ordering Standard TC Scissors

AJ-2624

**Operating (Standard) Scissors TC Gold**

A: 13 cm / 5" Str or Cvd  
 B: 14 cm / 5 1/2" Str or Cvd  
 C: 15.5 cm / 6 1/2" Str or Cvd  
 D: 18 cm / 7" Str or Cvd



Blunt / Blunt

AJ-2625

**Mayo Stille Scissors TC Gold**

A: 14.5 cm / 5 3/4" Str or Cvd  
 B: 17 cm / 6 3/4" Str or Cvd  
 C: 23 cm / 9" Str or Cvd

SURGICAL  
- STOCK -



Blunt / Blunt

AJ-2626

**Metzenbaum Scissors TC Gold**

A: 14 cm / 5 1/2" Str or Cvd  
 B: 17 cm / 6 3/4" Str or Cvd  
 C: 20 cm / 8" Str or Cvd  
 D: 23 cm / 9" Str or Cvd

Blunt / Blunt



AJ-2628

**Ortho Universal Scissors TC Gold**  
 12 cm / 4 1/3"

AJ-2627

**Mayo-Harrington Scissors TC Gold**

A: 20 cm / 8" Str or Cvd  
 B: 23 cm / 9" Str or Cvd  
 C: 28 cm / 11" Str or Cvd  
 D: 30 cm / 12" Str or Cvd



AJ-2629

**Mayo-Nobel Scissors TC Gold**  
 A: 16.5 cm / 6 1/2" Str or Cvd



## CARBIDE INSERTED WIRE & PIN CUTTERS

AJ-2630

Wire Cutting Plier TC Gold  
A: 15 cm / 6" Cut Upto 1.3mm  
B: 18 cm / 7" Cut Upto 1.6mm  
C: 23 cm / 9" Cut Upto 2.5mm

Angled



AJ-2631

Wire Cutting Plier TC Gold  
A: 15 cm / 6" Cut Upto 1.3mm  
B: 18 cm / 7" Cut Upto 1.6mm

SURGICAL

AJ-2632

Wire Cutting Plier TC Gold  
23 cm / 9" Cut Upto 2.5mm

AJ-2633

Wire Cutting Plier TC Gold  
18 cm / 7" Cut Upto 1.6mm



# CARBIDE INSTERTED WIRE & PIN CUTTERS

AJ-2634

Cannulated Pin Cutter TC Gold  
18 cm / 7" Cut Upto 1.5mm



AJ-2635

Front End  
Wire Cutting Plier  
TC Gold  
15 cm / 6"  
Cut Upto 1.3mm



AJ-2636

Front End  
Wire Cutting Plier  
TC Gold  
23 cm / 9"  
Cut Upto 2.5mm



AJ-2637

Front End  
Wire Cutting Plier  
TC Gold  
23 cm / 9"  
Cut Upto 2.5mm



# CARBIDE INSERTED PIN & PLATE CUTTERS

AJ-2638

Plate / Pin Cutting Plier  
TC Gold  
23 cm / 9"  
Cut Upto 3.0mm



AJ-2639

Pin / Wire Cutting Plier  
TC Gold / Adjustable  
23 cm / 9"  
Cut Upto 2.5mm



AJ-2640

Pin / Wire Cutting Plier  
TC Gold  
23 cm / 9"  
Cut Upto 2.5mm



AJ-2641

Front / Side  
Wire Cutting Plier  
TC Gold  
18 cm / 7"  
Cut Upto 1.6mm

# CARBIDE INSTERTED PIN CUTTERS HEAVYDUTY



AJ-2642

Heavy Duty  
Pin Cutting Plier  
TC Gold

- A: 30 cm / 12" Cut Upto 3mm
- B: 47 cm / 18 1/2" Cut Upto 5mm
- C: 56 cm / 22" Cut Upto 6mm
- D: 60 cm / 24" Cut Upto 7mm



AJ-2643

Heavy Duty  
Pin End Cutting Plier  
TC Gold

- A: 27 cm / 10 1/2" Cut Upto 3mm
- B: 38 cm / 15" Cut Upto 4mm



AJ-2644

Heavy Duty  
Rods / Steinmann Pin Cutting Plier  
TC Gold / Adjustable / Locking System

- A: 30 cm / 12" Cut Upto 3mm
- B: 38 cm / 15" Cut Upto 4mm
- C: 47 cm / 18 1/2" Cut Upto 5mm
- D: 56 cm / 22" Cut Upto 6mm



# INSTRUMENTS FOR TRUAMATOLOGY

## Drill Bits for Quick Coupling

Drill bit 1.1mm dia  
for threaded hole for 1.5mm screws

Drill bit 1.5mm dia.  
For threaded hole for 2.0mm screws and gliding hole for 1.5mm screws

Drill bit 2.0mm dia.  
For threaded hole for 2.7 mm dia.  
For gliding hole for 2.7mm screws

Item	Diameter	Total length	Usable length
AJ-2645	1.1mm	060mm	035mm
AJ-2646	1.5mm	085mm	060mm
AJ-2647	1.5mm	110mm	085mm
AJ-2648	2.0mm	100mm	145mm
AJ-2649	2.0mm	125mm	100mm
AJ-2650	2.7mm	100mm	075mm
AJ-2651	2.7mm	125mm	100mm
AJ-2652	2.7mm	100mm	075mm
AJ-2653	2.0mm	125mm	100mm

Drill bit 2.5mm dia.  
For threaded hole for 3.5 and 4.0mm screws

Item	Diameter	Total length	Usable length
AJ-2668	2.5mm	110mm	085mm
AJ-2669	2.5mm	180mm	155mm
AJ-2670	3.5mm	100mm	085mm
AJ-2671	3.5mm	195mm	170mm

Drill bit 3.2mm dia.  
For threaded hole for 4.5 and 6.5mm screws

Item	Diameter	Total length	Usable length
AJ-2677	2.0mm	100mm	145mm
AJ-2678	3.2mm	225mm	200mm
AJ-2679	3.2mm	145mm	120mm
AJ-2680	3.2mm	195mm	170mm
AJ-2681	4.5mm	145mm	120mm
AJ-2682	4.5mm	195mm	170mm

## Drill Bits for Jacobs Type Chuck

Drill Bit for Jacobs chuck

Item	Diameter	Total length	Usable length
AJ-2654	1.1mm	45mm	30mm
AJ-2655	1.5mm	70mm	55mm
AJ-2656	2.0mm	85mm	70mm
AJ-2657	2.5mm	095mm	080mm
AJ-2658	2.7mm	85mm	70mm
AJ-2659	3.2mm	130mm	115mm
AJ-2660	3.2mm	180mm	165mm
AJ-2661	3.5mm	095mm	080mm
AJ-2662	3.5mm	180mm	165mm
AJ-2663	4.5mm	130mm	115mm
AJ-2664	4.5mm	180mm	165mm



Tap for 2.0mm Cortex Screws  
Predrilling: 1.5mm dia.

Item	Thread length	Total length
AJ-2672	24mm	053mm
AJ-2673	38mm	100mm

Tap for 2.7mm Cortex Screws  
Predrilling: 2.0mm dia.

Item	Thread length	Total length
AJ-2683	33mm	100mm
AJ-2684	40mm	150mm

AJ-2685  
Tap for 2.7mm Cortex Screws  
total length 125mm, thread length 40mm  
predrilling: 2.0mm dia.

AJ-2665

Tap for 1.5mm Cortex Screws  
total length 50mm, thread length 20mm  
predrilling: 1.1mm dia.

AJ-2666

Tap for 6.5mm Cancellous Bone Screws  
length 195mm, predrilling: 3.2mm dia.

Tap for 4.0mm Cancellous Bone Screws

Item	Total length	Usable length
311.340'	110mm	085mm

AJ-2667

Tap, Cannulated, for 7.0mm Cannulated Screws  
length 230mm

Predrilling: 3.2mm

Item	Length	Type
AJ-2674	125mm	thread length 70mm
AJ-2675	175mm	with length markings

AJ-2676

Tap for 3.5mm Cortex Screws  
total length 110mm, thread length 50mm  
predrilling: 2.5mm dia.

AJ-2688

Tap for 4.5mm Cortex Screws  
total length 125mm, thread length 70mm  
predrilling: 3.2mm dia.



AJ-2689  
Countersink Shaft 1.5/2.0  
length 52mm, for mini quick coupling



AJ-2697  
Handle with quick coupling  
length 110mm  
for countersinks and  
instruments for the removal of damaged screws



AJ-2704  
Screwdriver Shaft, hexagonal, small  
length 100mm, for quick coupling  
For 2.7 to 4.0mm screws.



AJ-2710  
Screwdriver Shaft, Hexagonal, large  
length 100mm,  
Final tightening of the screw has to  
be done by hand.



AJ-2690  
Router, for Jacobs chuck  
length 90mm

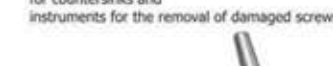

AJ-2698  
T-Handle with quick coupling  
length 80mm, for taps



AJ-2705  
Screwdriver Shaft, hexagonal, with Holding Sleeve  
for 1.5 and 2.0mm stainless steel screws  
with hexagonal socket.



AJ-2711  
Screwdriver Shaft, cruciform, 1.5/2.0, with Holding Sleeve  
length 50mm, for 1.5 and 2.0mm



AJ-2691  
Router, for quick coupling  
length 90mm

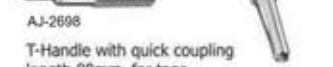

AJ-2699  
Handle, small, with mini quick coupling

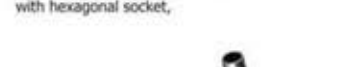

AJ-2706  
Screwdriver, hexagonal, with T-Handle,  
large to loosen tight screws.  
A normal screwdriver can be  
additionally inserted in the hollow  
shaft of the T-handle.

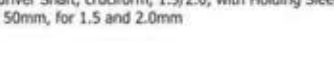

AJ-2712  
Screwdriver, hexagonal, small with groove  
length 200mm, for 2.7 to 4.0mm screws



AJ-2692  
Countersink, large  
length 180mm, for 4.5mm cortex screws



AJ-2700  
Handle, medium, with mini quick coupling

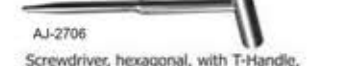

AJ-2707  
Screwdriver with Universal Joint, large  
length 290mm



AJ-2713  
Screwdriver, hexagonal, large, with groove  
length 240mm



AJ-2693  
Countersink Shaft 3.5mm  
length 72mm, for quick coupling,  
to countersink the screw head



AJ-2701  
Handle, large, with mini quick coupling

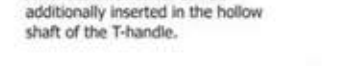

AJ-2708  
Screwdriver, hexagonal, with Holding Sleeve,  
length 165mm for 1.5 and 2.0mm stainless  
steel screws with hexagonal socket



AJ-2714  
Screwdriver, hexagonal, small, with Holding Sleeve  
length 200mm

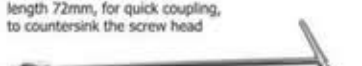

AJ-2694  
Countersink, cannulated, for 7.0mm Cannulated Screws  
length 230mm

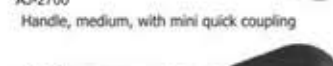

AJ-2702  
Allen Key, hexagonal, angled  
for 4.5 to 7.0mm screws



AJ-2709  
Holding Sleeve



AJ-2715  
Holding Sleeve for no. 314.030  
single, as spare

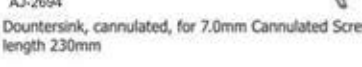

AJ-2695  
Handle with mini quick coupling

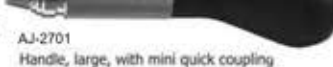

AJ-2703  
Allen Key, hexagonal, small, angled  
length 65mm, for 2.7 to 4.0mm screws



AJ-2716  
Holding Sleeve for Mini Screws  
single

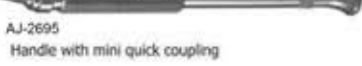

AJ-2696  
Hand Chuck for Kirschner Wires  
length 145mm, Spannbereich 0.6 to 1.6mm dia.

# INSTRUMENTS FOR TRUAMATOLOGY



AJ-2717  
Insert Drill Sleeve 3.5/2.5  
length 42mm, drill bit 2.5mm dia.



AJ-2718  
Insert Drill Sleeve 4.5/3.2  
length 80mm  
for long lag screws



AJ-2719  
Trocar 2.0mm dia.  
Length 118mm, for percutaneous insertion of 7.0mm cannulated screws



AJ-2720  
Drill Sleeve 4.5/2.0  
length 109mm, for percutaneous insertion of 7.0mm cannulated screws



AJ-2721  
Drill Sleeve 8.0/4.5  
length 100mm, for percutaneous insertion of 7.0mm cannulated screws



AJ-2722  
Handle for Drill Guides  
single



AJ-2723  
Drill Sleeve 3.0 with point  
length 55mm



AJ-2724  
Handle for Drill Guides  
for nos. 397.150 to 170. single



Item  
AJ-2725  
AJ-2726  
For diameter  
**1.5mm**  
**2.0/2.7mm**



AJ-2727  
Drill Sleeve 2.7



AJ-2728  
Double Drill Sleeve 1.5/1.01  
for 1.5mm cortex screws  
drill bits, 1.5 and 1.1mm dia



AJ-2729  
Double Drill Sleeve 2.0/1.5  
for 2.0mm cortex screws



AJ-2730  
Double Drill Sleeve 2.7/2.0  
for 2.7mm cortex screws



AJ-2731  
Double Drill Sleeve 3.5/2.5  
for 3.5mm cortex screws and 4.0mm cancellous  
bone screws  
drill bits 3.5 and 2.5 dia.



AJ-2732  
Double Drill Sleeve 4.5/3.2  
for 4.5mm cortex screws  
drill bits: 4.5 and 3.2mm dia



AJ-2733  
Double Drill Sleeve 6.5/3.2  
for 6.5mm cancellous bone screws  
drill bit: 3.2mm dia.



AJ-2734  
Universal Drill Sleeve 2.7  
Drill bits 2.0 and 2.7mm dia.,  
Suitable for LC-DCP and round hole plates.



AJ-2735  
Universal Drill Guide 3.5  
Drill bit 2.5 and 3.5mm dia., And tissue protection  
for taps nos.  
311.310/320/340, Suitable for LC-DCP and  
round hole plates.



AJ-2736  
Universal Drill Guide 4.5/3.2  
Drill bits 3.2 and 4.5mm dia.



AJ-2737  
DCP Drill Guide 2.0  
for neutral and load position  
drill bit 1.5mm dia.



AJ-2738  
DCP Drill Guide 2.7  
for neutral and load position  
drill bit 2.0mm dia.



AJ-2738  
DCP Drill Guide 3.5  
for neutral an load position, drill bit 2.5mm dia.



AJ-2739  
DCP Drill Guide 4.5  
for neutral and load position, drill bit 3.2mm dia.



AJ-2740  
LC-DCP Drill Guide 3.5  
for neutral an load position, drill bit 2.5mm dia.



AJ-2741  
LC-DCP Drill Guide 4.5  
for neutral and load position, drill bit 3.2mm dia.



AJ-2742  
DCP Hip Drill Guide 4.5  
for neutral and load position, for 4.5mm screws with DHS and  
angled blade plates, sleeve length 60mm, drill bit 3.2mm dia.



AJ-2743  
Triple Drill Sleeve 2.0  
with 3 holes, opposite side 1 hole



AJ-2744  
DCP Mandible Drill Guide 2.7 short  
drill bit 2.0mm dia.



AJ-2745  
DCP Mandible Drill Guide 2.7 long  
drill bit 2.0mm dia



AJ-2746  
Insert Drill Sleeve wit stop, for 4.5mm screws  
adjustable length to limit drilling depth,  
external dia. 4.5mm for drill bits of 3.2mm dia.



AJ-2747  
Parallel drill Guide 4.5  
for percutaneous insertion of 7.0mm cannulated screws



AJ-2748  
Parallel Wire Guide 2.0mm dia.



AJ-2749  
Depth Gauge for 2.7 to 4.0m screws  
measuring range up to 60mm



AJ-2750  
Depth Gauge for 2.7 to 4.0mm screws  
measuring range up to 60mm



AJ-2751  
Depth Gauge for 4.5mm to 6.5mm screws  
measuring range up to 110mm

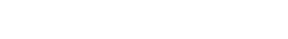

Bending Iron for plates 2.7 and 3.5  
Length 150mm, slid widths 2.5 and 4.5mm, required pairs  
Item  
AJ-2752  
AJ-2753  
Slid placement  
**4.5/2.5mm**  
**2.5/4.5mm**



Bending Iron for plates 1.5 and 2.0  
Length  
**130mm** Slid width  
**2.5mm**  
Item  
AJ-2754



AJ-2755  
Triple Drill Guide  
130° angle, for 130° angled blade plates and  
for condylar plates,  
drill bit 4.5mm dia.



AJ-2756  
Drill Guide with stop 3.5/2.7  
to limit drilling depth



AJ-2757  
Protection Sleeve 11.0/8.0  
for percutaneous insertion of 7.0mm cannulated screws



AJ-2758  
Holding Sleeve  
length 80mm, for 2.7 to 4.0mm screws

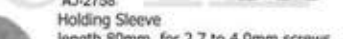

AJ-2759  
Holding Sleeve for  
lengt 80mm for 2.7mm screws and  
3.5mm cannulated screws

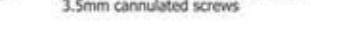

AJ-2760  
Holding Sleeve, large, length 120mm  
for Nos. 314.190/240/260/270/275



AJ-2761  
Screw Forceps, self-holding  
length 85mm, to take screws out of the screw racks



AJ-2762  
Drill Sleeve, pointed



AJ-2763  
Bending Iron LC-DCP/DCP  
length 250mm, for small and broad LC-DCP, DCP  
slit widths 5 and 7mm, Required in pairs



# INSTRUMENTS FOR TRUAMATOLOGY



AJ-2764  
Bending Iron for Kirschner Wires  
length 120mm, for 1.25 to 2.5mm dia.



AJ-2765  
Bending Iron for Kirschner Wires  
length 115mm, for 0.8 to 1.25mm dia.



AJ-2766  
Bending Iron for Reconstruction Plates 3.5 and 4.5  
length 190mm, required in paris



AJ-2767  
Handle with Sleeve  
wit rotating drill guide and anchoring point



AJ-2768  
Trocar Point, large, for number 397.110  
for nos. 387.000/397.110



AJ-2769  
Cheek Retractor Ring, for number 397.110  
for nos. 387.000/397.110



AJ-2770  
Combination Wrench 11mm  
length 140mm



AJ-2771  
Pin Wrench  
length 120mm, 4.5mm dia.  
For tension device, distractor and knurted  
nut of insertion handle for instramedullary nail



AJ-2772  
Socket Wrench 11mm  
length 200mm



AJ-2773  
Slotted Hammer  
length 270mm



AJ-2774  
Inserter/Extractor, with Adjustable Clamps  
length 270mm, for the insertion and extraction of angled plates for  
adults and hip plates for adolescents and children as well as tibial  
plateau osteotomy plates.



AJ-2775  
Inserter/Extractor  
length 175mm, for infant hip plate and mini hip plate.



AJ-2776  
Bending Pliers for Reconstruction Plates 2.7 and 3.5  
length 240mm



AJ-2777  
Bending Pliers for plate 2.4 to 4.0  
length 230mm



AJ-2778  
Bending Pliers for plates



AJ-2779  
Anvil, narrow



AJ-2780  
Anvil, large



AJ-2781  
Bending Press  
length 400mm



AJ-2782  
Cutter for thin plates 1.5 to 2.7  
length 256mm



AJ-2783  
Bending Pliers  
for reconstruction plates 2.7,  
length 270mm, required in paris



AJ-2784  
Cerclage Wire Tightener  
length 260mm  
for twisting, for temporary fixation during reduction



AJ-2785  
Tension Device, articulated  
Span 20mm, can also be used as a distractor.  
Colour scale: yellow up to 500N, green up to 1000N,  
red above 1000N.



AJ-2786  
Chisel Guide  
with adjustable angle

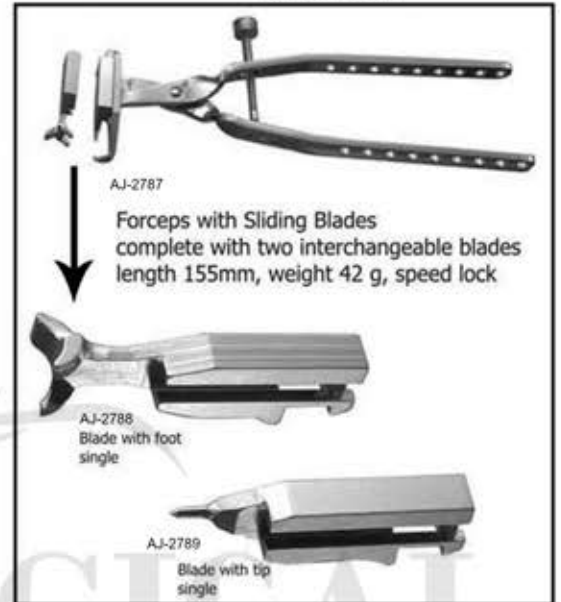

AJ-2787  
Forceps with Sliding Blades  
complete with two interchangeable blades  
length 155mm, weight 42 g, speed lock



AJ-2788  
Blade with foot  
single



AJ-2789  
Blade with tip  
single



AJ-2790  
Measuring Device  
fro drill bits, screws, Kirschner wires, and Stehmann pins



AJ-2791  
Holding Clip



AJ-2792  
Wire Passer  
45mm bending diameter



AJ-2793  
Wire Passer  
70mm bending diameter



AJ-2794  
Wire Tightener  
length 240mm, with handle and two pegs



# INSTRUMENTS FOR TRUAMATOLOGY



**Cerclage Wire with eye**  
Packs of 10 Wires

Item	Diameter	Length
	0.80mm	280mm
	1.00mm	280mm
	1.25mm	280mm
	1.00mm	600mm
	1.25mm	600mm
	1.50mm	280mm
	1.50mm	600mm

**Cerclage Wires without eye**  
In precut lengths  
packs of 10 wires

Item	Diameter	Length
	0.40mm	150mm
	0.60mm	175mm
	0.80mm	200mm
	1.00mm	250mm
	1.25mm	300mm

**Diameter Ø**

- A: 0.2 mm
- B: 0.3 mm
- C: 0.4 mm
- D: 0.5 mm
- E: 0.6 mm
- F: 0.7 mm
- G: 0.8 mm
- H: 0.9 mm
- I: 1.0 mm
- J: 1.2 mm
- K: 1.5 mm

**Bone Wire Soft**  
Coil of 10 Meters  
Implantable Material

**Shanz Screws**  
Implantable Material

2 x 60 x 15 mm	5 x 150 x 30 mm
3 x 60 x 15 mm	5 x 160 x 40 mm
3 x 80 x 15 mm	5 x 180 x 40 mm
3 x 80 x 20 mm	5 x 200 x 40 mm
3 x 100 x 15 mm	5 x 220 x 40 mm
3 x 120 x 15 mm	6 x 120 x 40 mm
4 x 80 x 20 mm	6 x 140 x 40 mm
4 x 100 x 20 mm	6 x 150 x 40 mm
4 x 120 x 20 mm	6 x 160 x 40 mm
4 x 140 x 20 mm	6 x 180 x 40 mm
5 x 120 x 30 mm	6 x 200 x 40 mm
5 x 140 x 30 mm	6 x 220 x 40 mm

## Kirschner Wire Implantable Material

Packs of 10 units

St. steel	Diameter	Length	Titanium Alloy
AJ-2824	0.60mm	070mm	492.060
AJ-2825	0.80mm	070mm	492.080
AJ-2826	0.80mm	150mm	492.090
AJ-2827	1.00mm	150mm	492.100
AJ-2828	1.00mm	280mm	492.110
AJ-2829	1.25mm	150mm	492.120
AJ-2830	1.25mm	280mm	492.130
AJ-2831	1.40mm	150mm	492.140
AJ-2832	1.40mm	280mm	492.150
AJ-2833	1.60mm	150mm	492.160
AJ-2834	1.80mm	150mm	492.170
AJ-2835	1.60mm	280mm	492.180

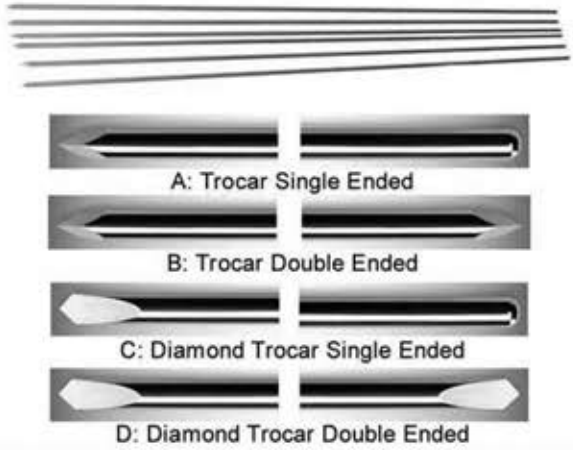

## Kirschner Wire Implantable Material

Packs of 10 units

St. steel	Diameter	Length	Titanium Alloy
AJ-2837	1.80mm	280mm	492.190
AJ-2838	2.00mm	150mm	492.200
AJ-2839	2.00mm	280mm	492.210
AJ-2840	2.00mm	400mm	492.230
AJ-2841	2.50mm	150mm	492.250
AJ-2842	2.50mm	280mm	492.260
AJ-2843	2.50mm	400mm	492.280
AJ-2844	3.00mm	150mm	492.300
AJ-2845	3.00mm	280mm	492.310
AJ-2846	3.00mm	400mm	492.330